

Mihama Units 1 & 2 Radiological Management of System Decontamination for Decommissioning

Radiological Unit, Radiation Management Section,
Mihama Nuclear Power Station

The Kansai Electric Power Corporation, Inc.

October 25, 2018

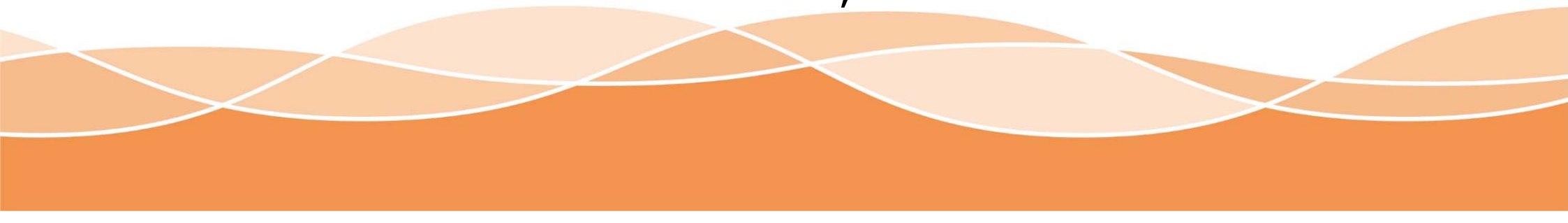

【Table of Contents】

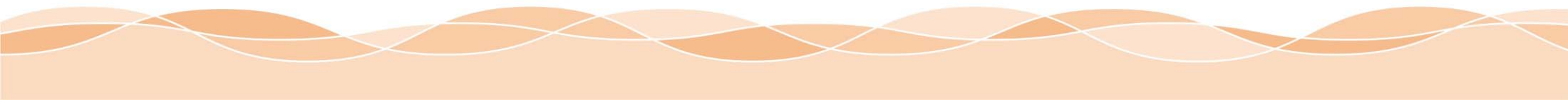
- 1 . Overview of KEPCO's Nuclear Power Plants**
 - 2 . Outline of Decommissioning Process**
 - 3 . System Decontamination Work**
 - 4 . Radiological Management during System Decontamination Work**
- 

1. Overview of KEPCO's Nuclear Power Plants

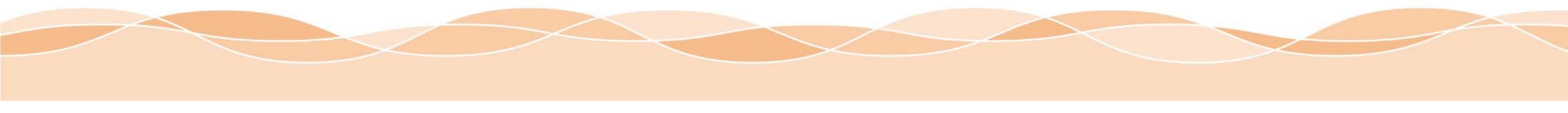

Overview of KEPCO's Nuclear Power Plants

Total power output decreases from 9,768MW to 6,578MW following decommissioning of Mihama 1/2 and Ohi 1/2.

■ Nuclear Power Division



■ Community Relations Division

■ Takahama NPS



Unit	Gross output (MW)	Date put into service
1	826	1974.11
2	826	1975.11
3	870	1985. 1
4	870	1985. 6
Total	3,392	-

■ Ohi NPS

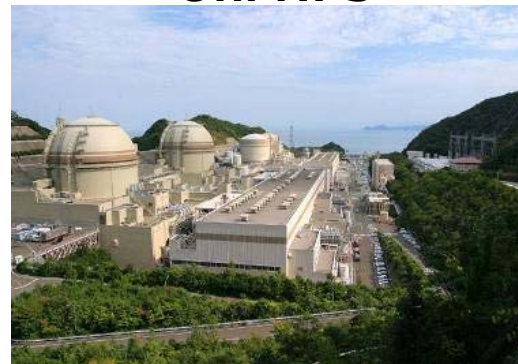

Unit	Gross output (MW)	Date put into service
(1	1,175	1979. 3
2	1,175	1979.12
3	1,180	1991.12
4	1,180	1993. 2
Total	2,360	-

■ Mihama NPS



Unit	Gross output (MW)	Date put into service
(1	340	1970.11
2	500	1972. 7
3	826	1976.12
Total	826	-

•Approx. 2000 employees are working for nuclear power generation in Fukui prefecture (About 40% of the employees have originated from Fukui prefecture).

Mihama unit 1 started commercial operation in November 1970 as Japan's first PWR.

Mihama NPP generated electricity (capacity factor)
 FY2010: 12.12billion kWh (83.0%)
 FY2011: 3.89billion kWh (26.6%)
 FY2012~ 0.0 kWh (0.0%)

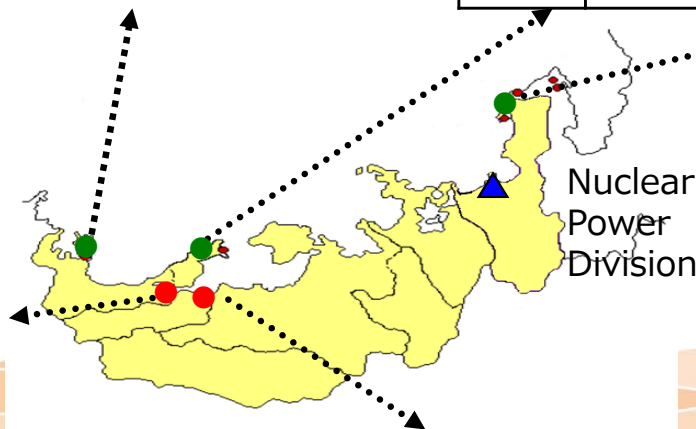

Nuclear Training Center

NPP Operation Support Center

2. Outline of Decommissioning Process

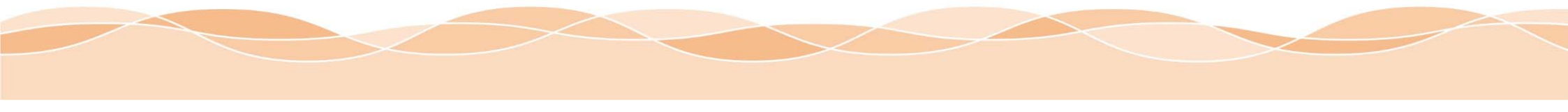

Flow of Decommissioning of Mihama 1 & 2

○Mihama unit 1

In a long-term shutdown state since November 2010 (Fuel was unloaded in February 2013 although the unit was in a standby condition for restart with the fuel loaded in the core.)

○Mihama unit 2

In a long-term shutdown condition since December 2011 (Fuel was unloaded in January 2012 when the unit underwent the periodic inspection.)

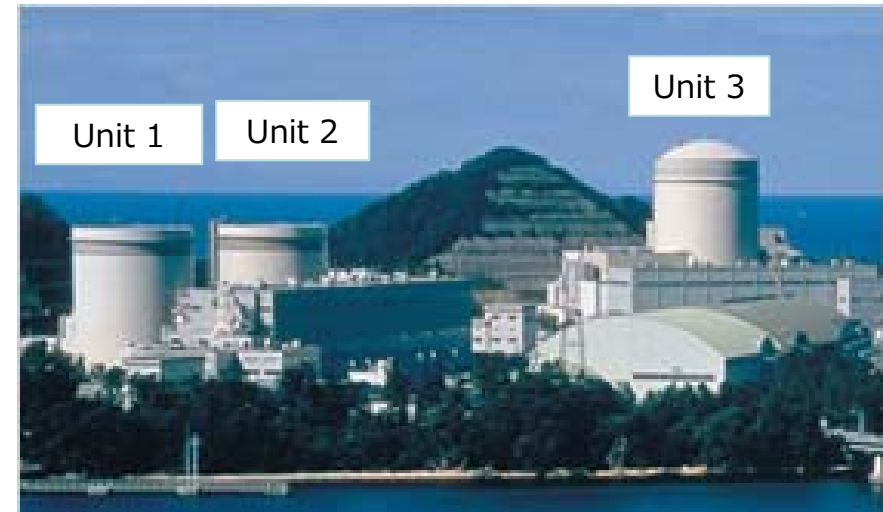

June 28, 2010 Mihama 1 received regulatory approval for changes in the Tech. Spec. associated with its long-term maintenance management policy.

March 11, 2011 East Japan Great Earthquake (Fukushima Daiichi accident)

July 28, 2012 Mihama unit 2 received regulatory approval for changes in the Tech. Spec. associated with its long-term maintenance management policy. <confirming the plant integrity at the 60th year of operation by conducting aging evaluation>

July 8, 2013 The new regulatory requirements were put into effect:

- Enhancement of design basis to prevent severe accidents from occurring
- Introduction of new criteria to address severe accidents and terrorist attacks



March 17, 2015 A decision was made on decommissioning of Mihama 1&2.

April 19, 2017 Mihama 1&2 decommissioning plans were approved.

Mihama 1 & 2 Decommissioning Plan ①

- The entire decommissioning process (approx. 30 years) is divided into 4 phases to promote the project in a step-wise manner.
- The decommissioning process shall be pursued in a steady manner based on the basic policies (① putting top priority to safety, ② reducing radiation doses and radioactive waste, and ③ maintaining/managing safeguard functions) .

	Preparatory work 2017~2021	Dismantling/removal of peripheral facilities 2022~2035	Dismantling/removal of reactor region 2036~2041	Dismantling/ removal of buildings 2042~2045
Mihama units 1 & 2 decommissioning process	System Decon.			
	Survey of residual radioactivity			
	Removal of nuclear fuel			
	Dismantling/removal of secondary system facilities			
	Dismantling/removal of peripheral facilities			
			Dismantling/removal of reactor region	
				Dismantling/removal of buildings
	Safe storage			
	Decontamination of equipment			
				Disposal of radioactive waste

Mihama 1 & 2 Decommissioning Plan ②

① Preparatory work (FY2017 (after regulatory approval)~FY2021)

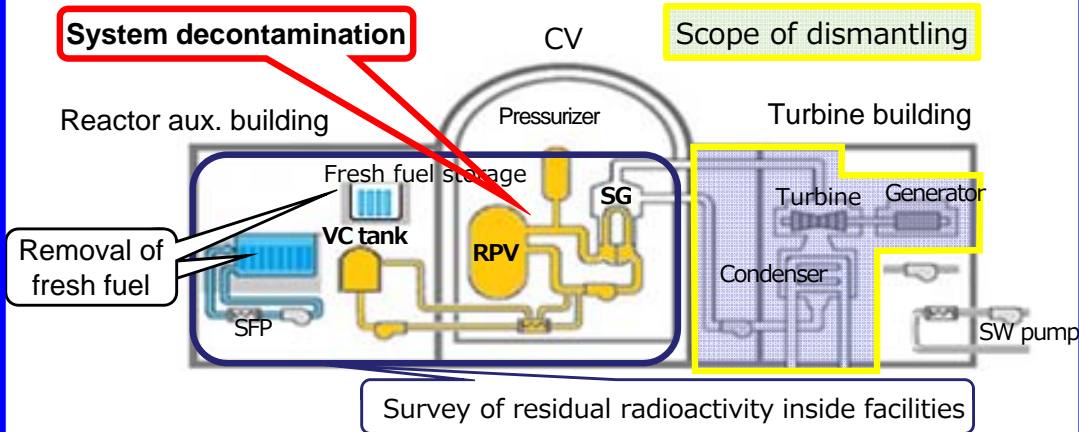

Item	<ul style="list-style-type: none"> •System decontamination •Survey of residual radioactivity inside facilities •Removal of fresh fuel •Dismantling/removal of secondary system facilities •Safe storage (•Maintenance & management of facilities) 	Work activity	<ul style="list-style-type: none"> •Chemical decontamination to remove radioactive material attached on system surface •Clarify radioactivity distributions inside facilities •Bring 108 fresh fuel assemblies out of the facilities •Disassemble 2 turbines, a condenser and other components
------	--	---------------	--

② Dismantling/removal of peripheral facilities (FY2022~2035)

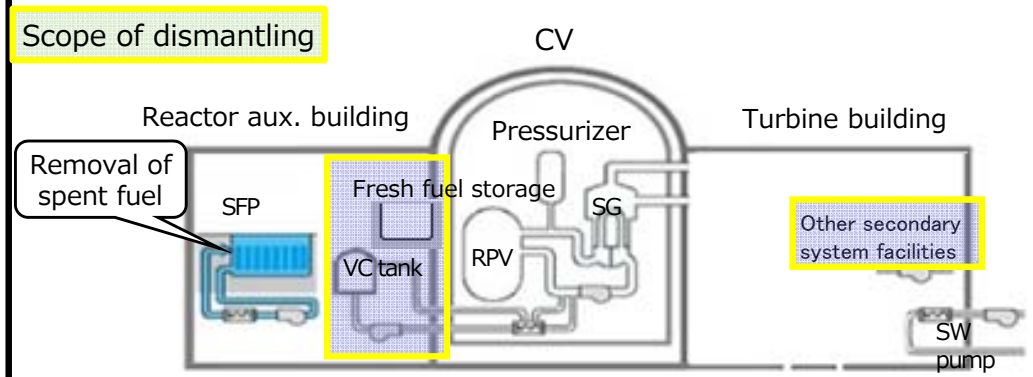

Item	<ul style="list-style-type: none"> •Dismantling/removal of peripheral facilities •Removal of spent fuel •Dismantling/removal of secondary system facilities (continuously from stage ①) •Safe storage (•Maintenance & management of facilities) 	Work activity	<ul style="list-style-type: none"> •Sequentially dismantling primary system facilities excluding those to be maintained •Bring 741 spent fuel assemblies out of SFP •Dismantle secondary system facilities which were not subjected to stage ①
------	---	---------------	---

③ Dismantling/removal of reactor region (FY2036~2041)

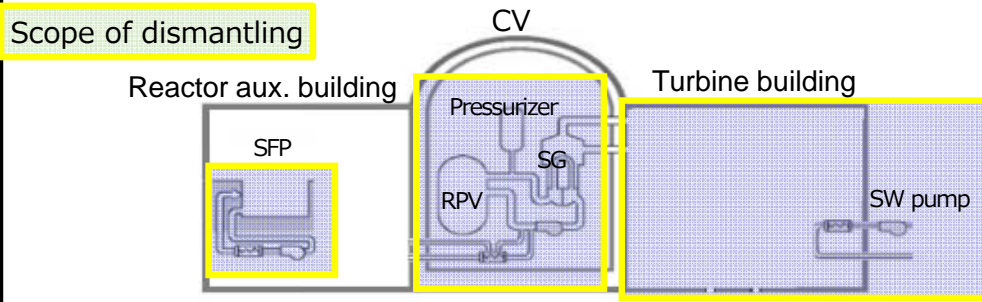

Item	<ul style="list-style-type: none"> •Dismantling/removal of reactor region •Dismantling/removal of secondary system facilities •Dismantling/removal of peripheral facilities (continuously from stage ②) (•Maintenance & management of facilities) 	Work activity	<ul style="list-style-type: none"> •Dismantle RPV and core internals mainly those having high radioactivity •Dismantle primary system facilities which were not subjected to stage ① •Dismantle secondary system facilities which were not subjected to stages ① and ②
------	--	---------------	---

④ Dismantling/removal of buildings (FY2042~2045)

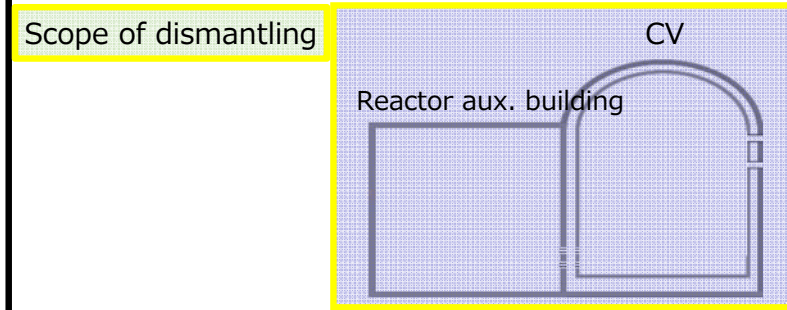

Item	<ul style="list-style-type: none"> •Cancellation of controlled areas •Dismantling/removal of buildings 	Work activity	<ul style="list-style-type: none"> •Dismantle buildings from which all radioactive material has been removed
------	--	---------------	---

Scope of Decommissioning Work in Coming Years

- For the primary system, system decontamination, radioactivity survey and removal of fresh fuel will be performed (work other than dismantling).
- For the secondary system, dismantling of components inside the turbine building will be performed.

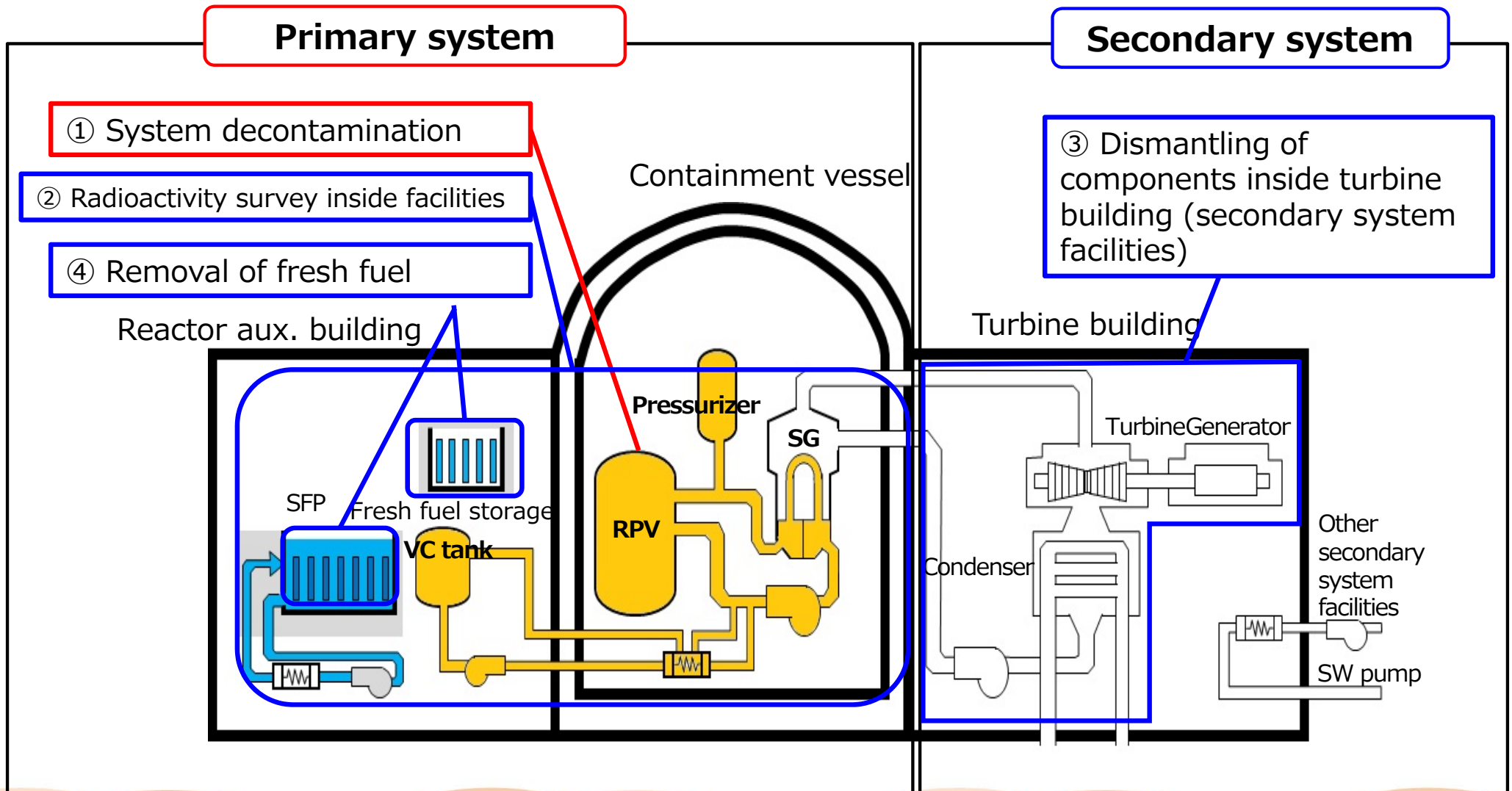

Decommissioning Work Schedule in Coming 3 FYs

Work activity	FY2017			FY2018	FY2019
① System decontamination	Preparatory work (Improvement of existing piping geometries, etc.)	Decontamination	cleanup	At this point of time	
② Radioactivity survey		Radioactivity measurement, sampling, analysis and evaluation			
③ Dismantling of turbine equipment		Dismantling and removal			
④ Removal of fresh fuel		Removal and transportation (under study)			

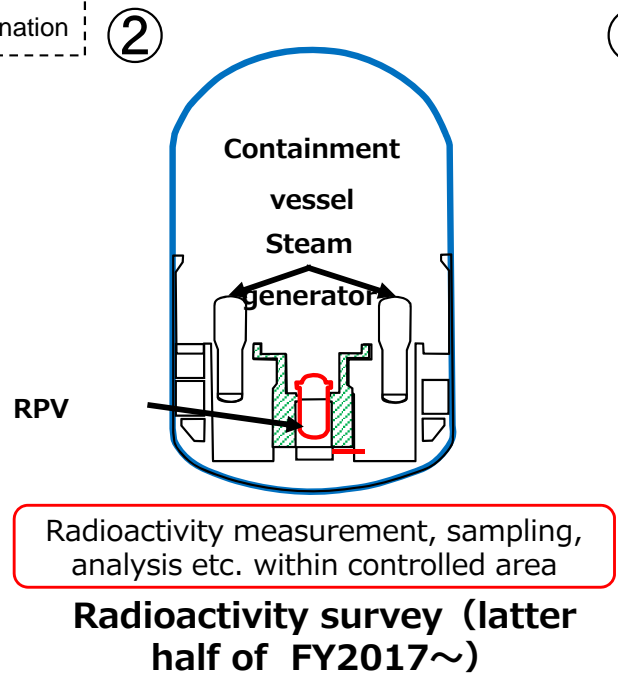
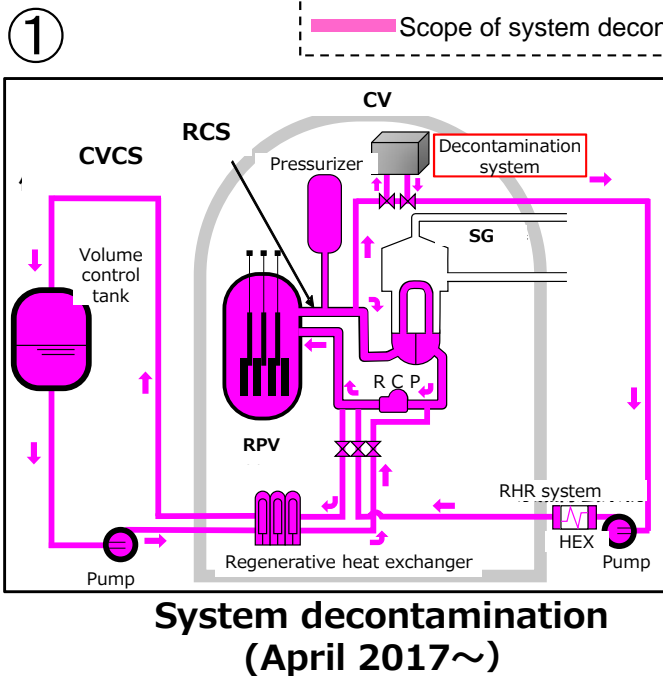

○In FY2017, system decontamination work was conducted to reduce exposure doses received by workers during dismantling work.
 ○In FY2018, radiological survey and dismantling of components inside the turbine building are being performed following system decontamination.

3 . System Decontamination Work

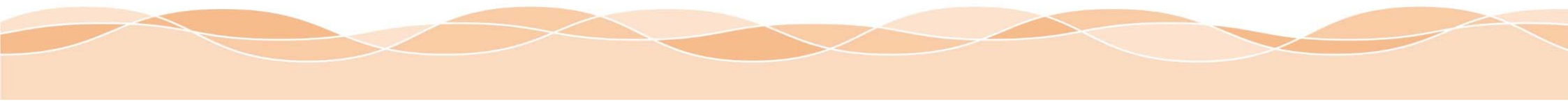

Summary

1. Objectives of system decontamination

It is necessary to decontaminate the relevant systems before the start of dismantling work in order to;

- ① improve the working environment during dismantling (reduction of radiation exposure, lighter radiological protection outfits)
- ② reduce the amount of radioactive solid waste

Shortening of the dismantling process can be also expected as a secondary effect.

Package system decontamination utilizing existing components, such as pumps and heat exchangers, was introduced taking into account overseas experience.

Decontaminating individual components is irrational considering the radiation exposure, and time and effort. It is reasonable to perform package system decontamination in the early stage when the integrity of existing system components is still maintained.

2. Selection of systems

The target systems are RCS, CVCS and RHR system whose inner surface is in contact with reactor coolant and thus contaminated with residual radioactive material (the systems in service during plant operation).

3. Target of decontamination

The target decontamination factor (DF) is set at 30 taking into account both advantages and disadvantages associated with decontamination.

$$DF = \frac{\text{Dose equivalent rate (before system decon.)}}{\text{Dose equivalent rate (after system decon.)}}$$

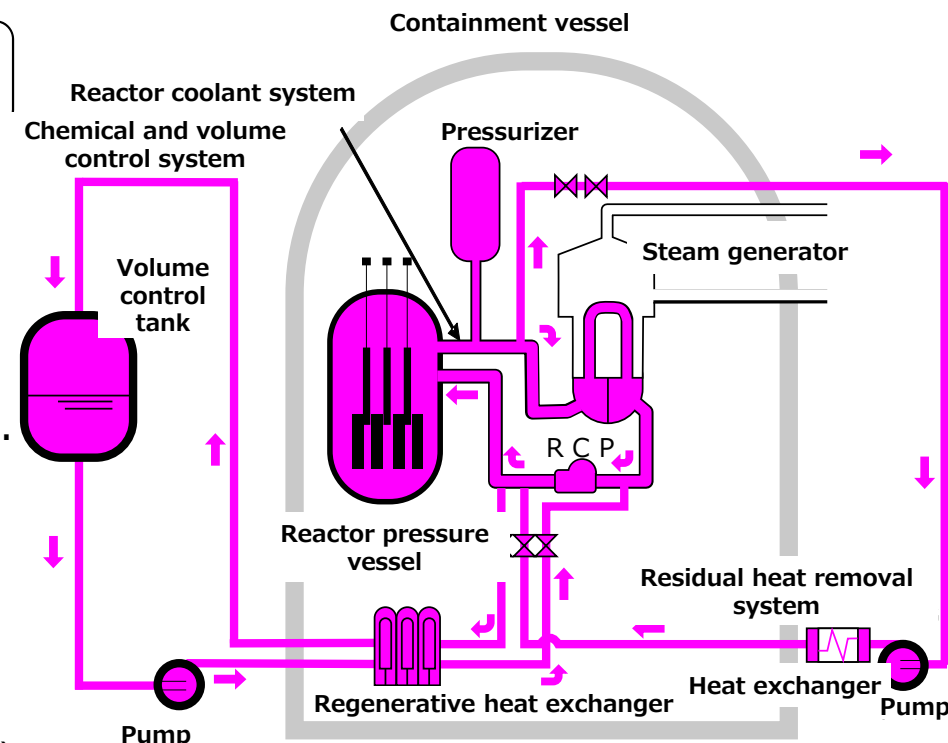

Scope of system decontamination (RCS, CVCS, RHRs)

○Chemical Cleaning: CORD method

One cycle consisting of oxidation, decontamination, decomposition and purification is repeated to dissolve inner crud and remove it.

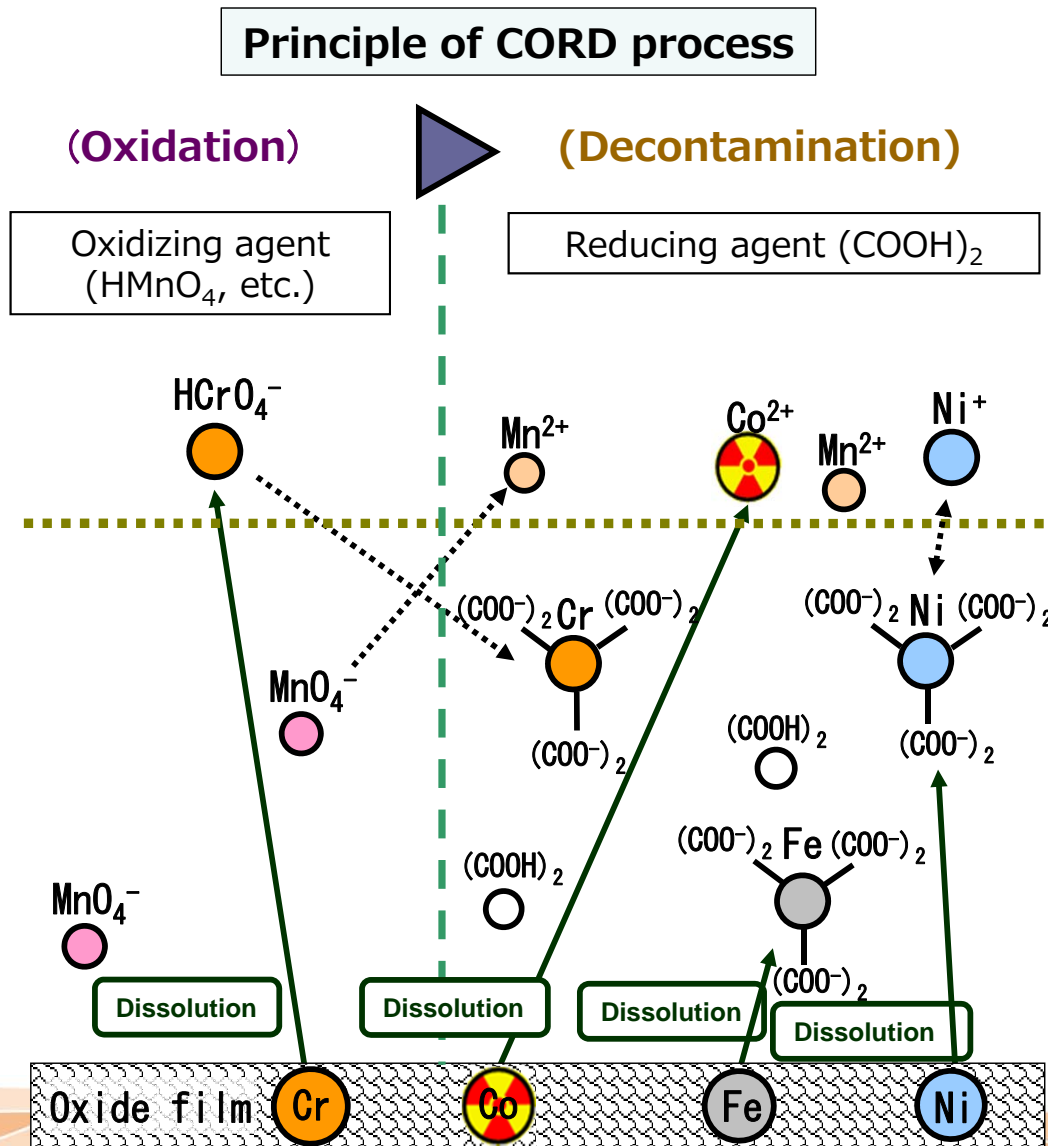

① Oxidation process :

Oxidize Cr³⁺ with MnO₄⁻ (permanganate ion)
(Cr³⁺→Cr⁶⁺)

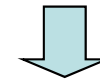

② Decontamination process :

Dissolve MnO₄⁻ and MnO₂ (manganese dioxide) with trace oxalic acid to collect Ni⁺ as cation ion.
Dissolve and decompose Fe^{3+/2+}, Ni²⁺ and Co²⁺ with oxalic acid.



③ Decomposition process :

Inject hydrogen peroxide and dissolve oxalic acid with ultraviolet rays.



④ Purification process :

Purify decomposed radioactive nuclides, metals and chemicals with ion exchange resin.

○ Mechanism of system decontamination

After connecting a temporary decontamination system to the target system, inside of which a lot of radioactive materials remain (RCS, RCV, CVCS, RHRS, etc.), decontamination agent added with chemicals is circulated the system and radioactive materials are removed by ion exchange resin inside the decontamination system.

[System diagram]

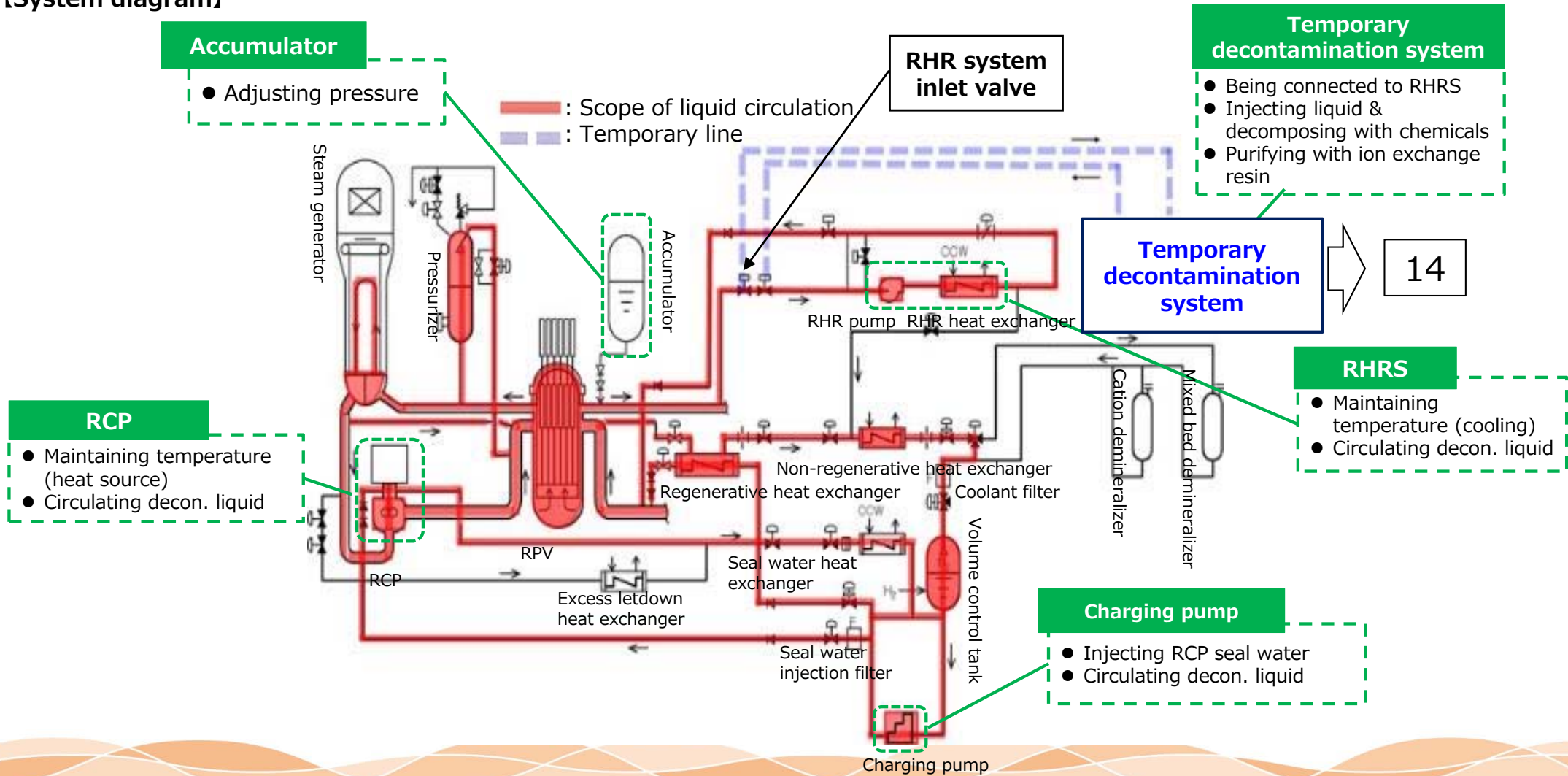

Configuration of Temporary Decontamination System

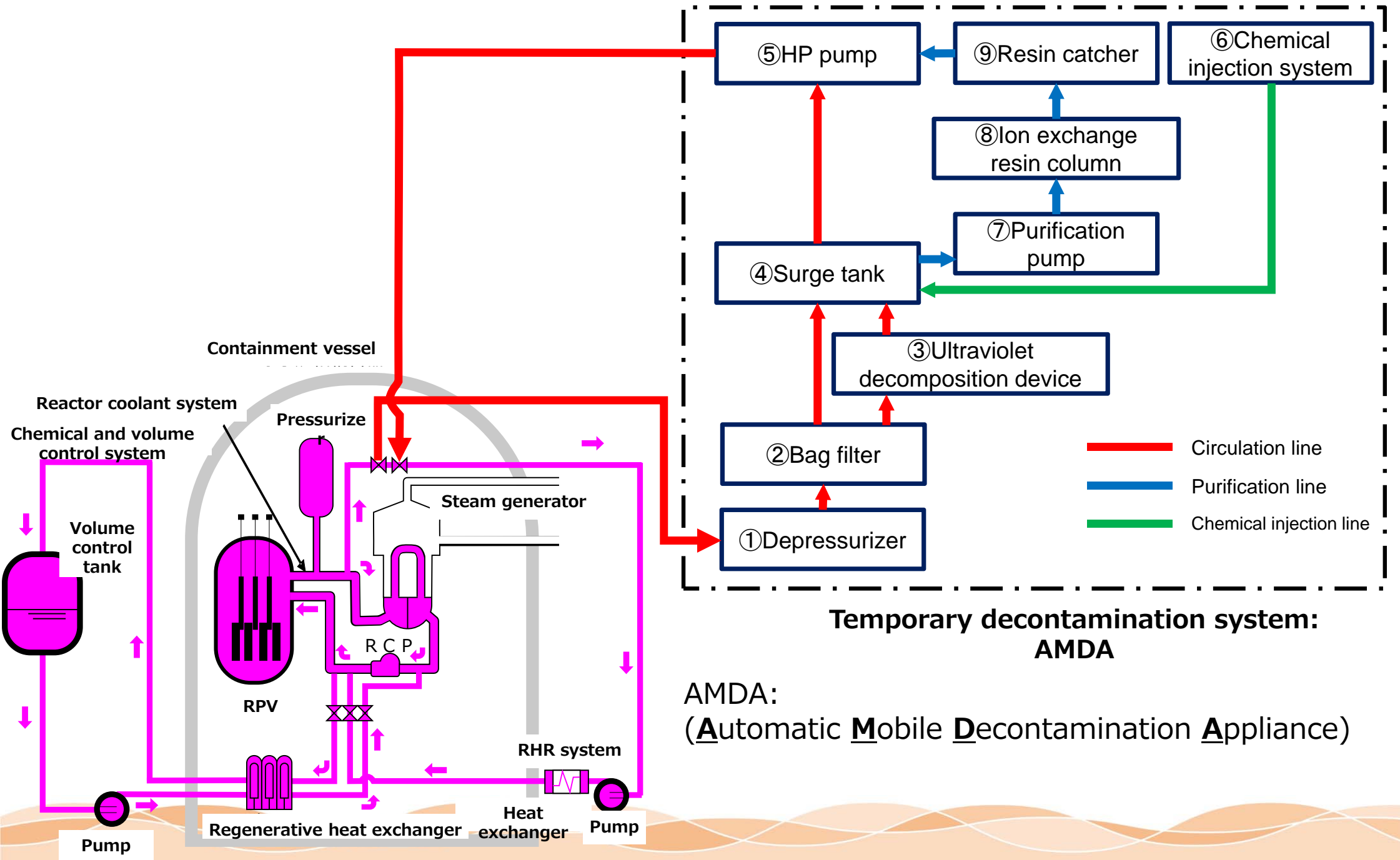

Decontamination system installed at EL.10M

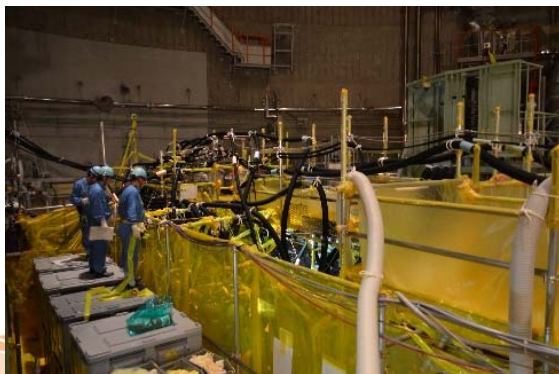
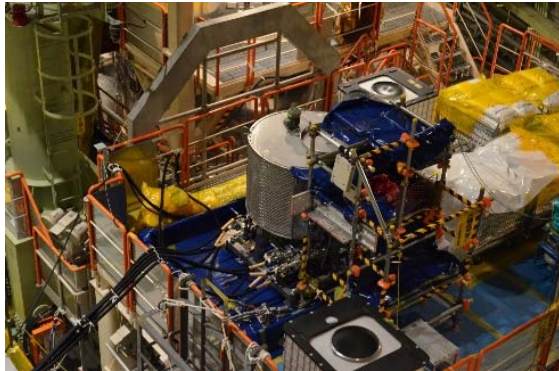
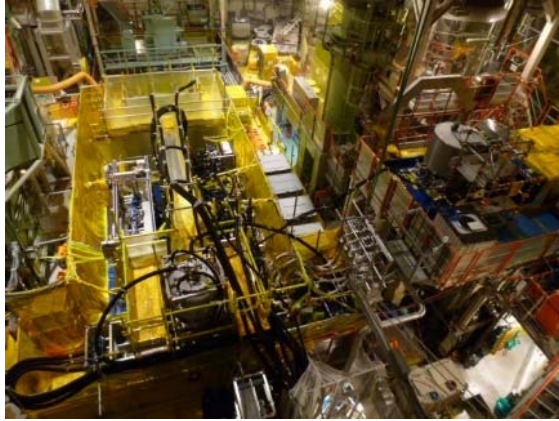

Flange connection of system piping

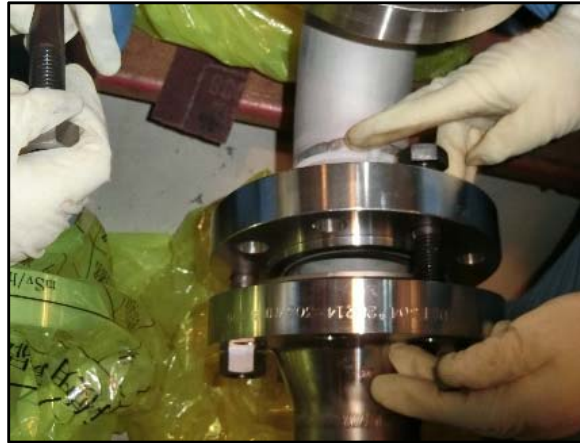

Installation of temporary floor (upper cavity)

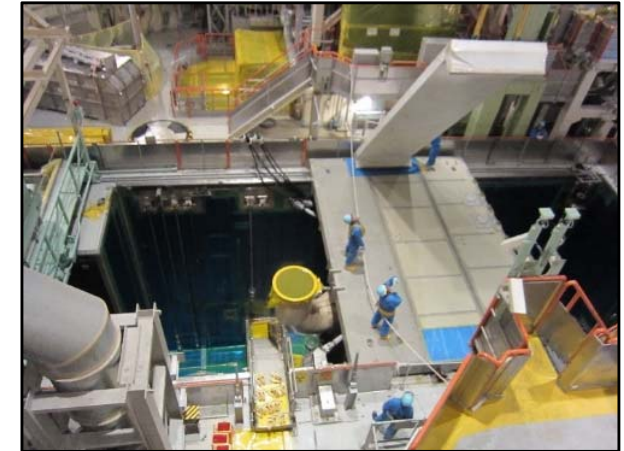

(System configuration)

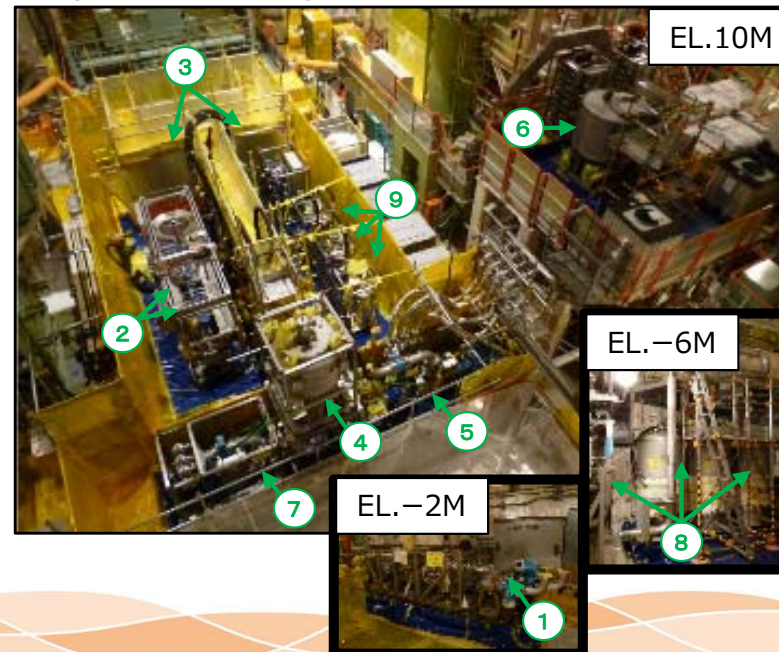

- ① Depressurizer
- ② Bag filter
- ③ UV decomposition system
- ④ Surge tank
- ⑤ HP pump
- ⑥ Chemical injection system
- ⑦ Purification pump
- ⑧ Ion exchange resin
- ⑨ Resin catcher

(1) Decontamination schedule

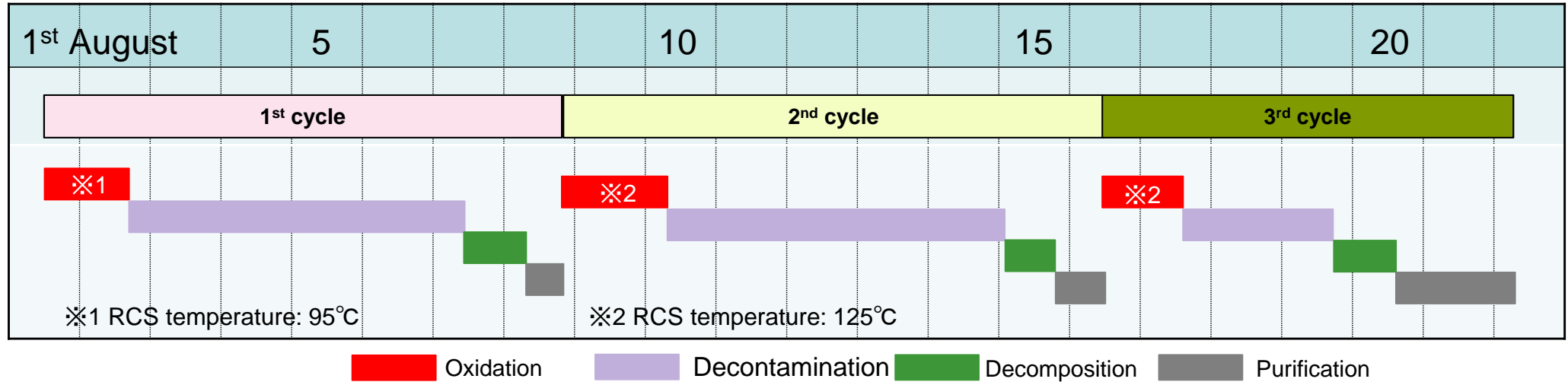

(2) Measures doses

	Decontamination factor (average)
SG tube	89
SG shell	140
RCS pipe, etc.	32

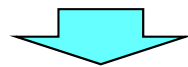

The target DF of 30 was achieved.

(3) Removed metal (kg)※

Fe	Cr	Ni	Zn	Total
65	25	40	—	130

※Aprox.

(4) Spent resin (m³)

Cation resin	Anion resin	Total
4.7	1.15	5.85

(1) Decontamination schedule

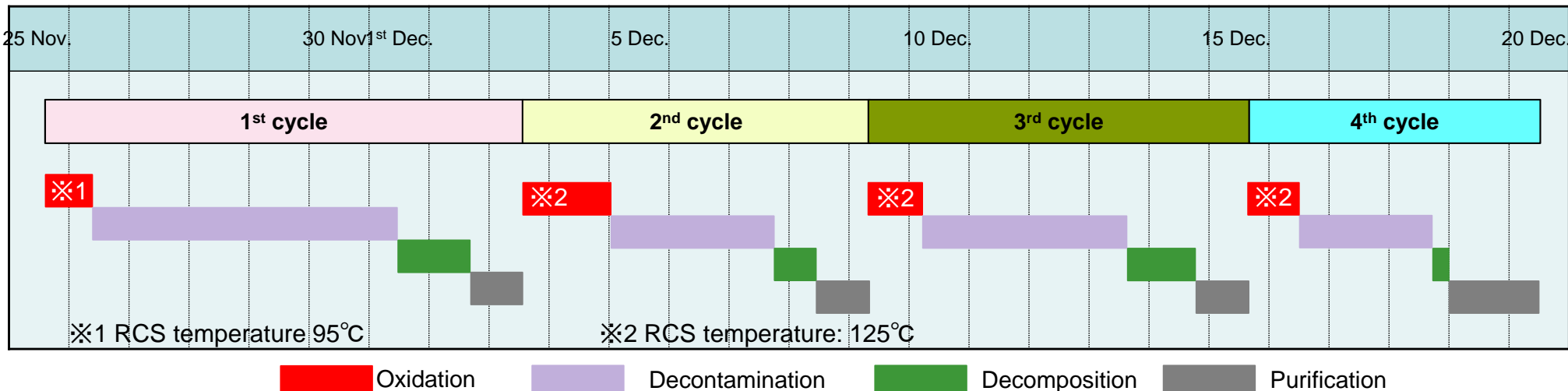

(2) Measured doses

	Decontamination factor (average)
SG tube	174
SG shell	67
RCS pipe, etc.	30

(3) Removed metal (kg)※

Fe	Cr	Ni	Zn	Total
55	35	55	5	150

※ approx.

(4) Spent resin (m³)

Cation resin	Anion resin	Total
7.2	1.4	8.60

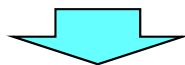

The target DF of 30 was achieved.

4. Radiological Management during System Decontamination Work

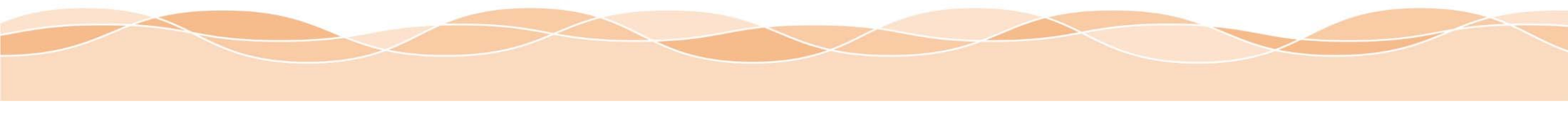

○ Outline

An effort was made to control doses to be received by workers during the period of system decontamination by setting the following targets.

【Mihama unit 1】

1. Reduction of exposures

(1) Total dose from planned exposure (unit: man/Sv)

Planned dose	Actual dose	Increase/decrease (%)
0.31	0.105	-66

(2) Individual dose (unit: mSv)

Daily (planned/actual)	Throughout the period (planned/actual)
3.00 / 0.73	9.00 / 1.89

2. Protection of physical contamination

Item	Target	Actual	Remarks
Internal exposure	0	0	—
Whole body monitor alarm sounding ratio	0.015%	0.011%	The target was set referring to past periodic outages.

【Mihama unit 2】

1. Reduction of exposures

(1) Total dose from planned exposure

(unit: man/Sv)

Planned dose	Actual dose	Increase/decrease (%)
0.22	0.149	-32

(2) Individual dose

(unit: mSv)

Daily (planned/actual)	Throughout the period (planned/actual)
0.90 / 0.73	5.00 / 0.73

2. Protection of physical contamination

Item	Target	Actual	Remarks
Internal exposure	0	0	—
Whole body monitor alarm sounding ratio	0.011%	0.0%	The target is the actual value of unit 1.

【For both units 1 and 2】

1. Reduction of radioactive waste

(1) Radioactive solid waste

Spent resin (m ³) (planned/actual)		Bag filter (piece) ^{※ 1} (planned/actual)	Water filter ^{※ 2} (piece) ^{※ 1} (planned/actual)
Cation ion	Anion ion		
8.7/11.90	1.7/2.55	19/12	17/16

※ 1 : contained in a drum shielded with 10cm thick concrete shielding

※ 2 : Water filters refer to the coolant filter and seal water filter.

(2) Radioactive gaseous waste

Planned release	Actual release
N D	N D

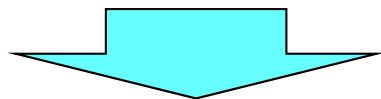

System decontamination work at Mihama units 1&2 has been successfully completed with no problems of radiological management.

Reduction of Exposures (Temporary Shielding ①)

○ Installation of temporary shielding

Temporary shielding sheets were installed in front of the operation center and around the workplace to reduce the dose equivalent rate considering the effects of spent resin transferred from the resin column during the system decontamination work. Main locations of temporary shielding are shown below (at unit 1);

EL inside CV	Location	Number of shielding sheets	Dose equivalent rate (mSv/h)		Reduction (%)	Photo
			Before install.	After install.		
+4.0m	Above grating	584	0.07	0.01	-86	①
	In front of operation center		0.07	0.01	-86	②
-2.15m	Around grating	555	1.3	0.24	-85	③
	Location of liquid waste sampling		-	0.02	-	④
-6.15m	Passage	528	-	1.1	-	⑤
	Location of local valve operation		-	0.08	-	⑥

- : No records before installation to calculate the reduction ratio

① Above grating at EL 4.0m



② In front of operation center at EL 4.0m



③ Around grating at EL-2.15m



④ Sampling location at EL-2.15m



⑤ Passage at EL-6.15m



⑥ Location of local valve operation at EL-6.15m

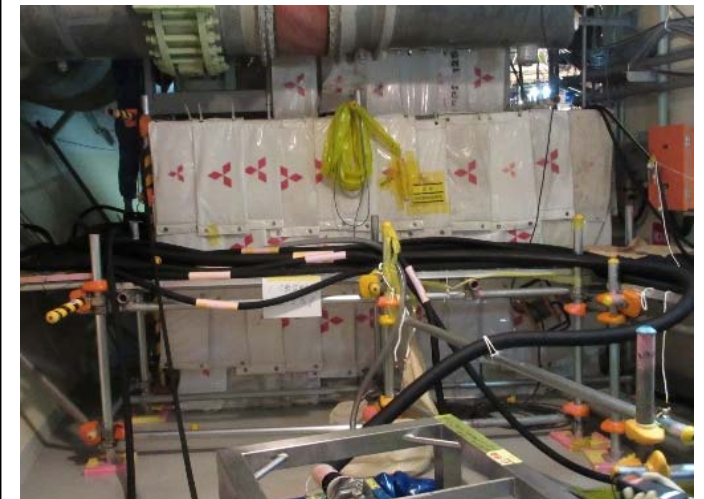

○ Designation of areas subject to special measures

The areas subject to the special measures, which are specified in the Tech. Spec. , were designated in advance and access control was performed by marking with signs and using ropes to prevent other workers than those authorized by the manager of radiation control will not enter into those areas without reason considering potential increase in the dose equivalent rate to above 1 mSv/h due to system decontamination work and transfer of spent resin.



Signs and message boards

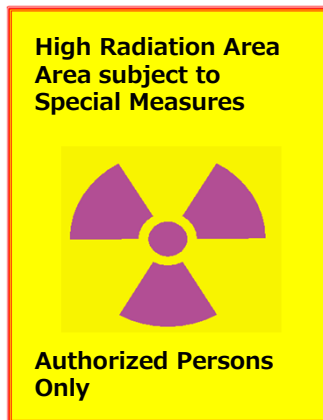

Armband

○ Major technologies adopted to reduce exposures

1. Adoption of remote operation system

A remote operation system was adopted to fill bag filters having a high dose equivalent rate (87 mSv/h at the highest) into drums for reducing workers' exposures.

2. Remote monitoring using cameras

Cameras were installed at the location where monitoring was necessary, including system decontamination system and spent resin transfer piping, to measure dose equivalent rates remotely for reducing radiation work under a high dose equivalent environment.

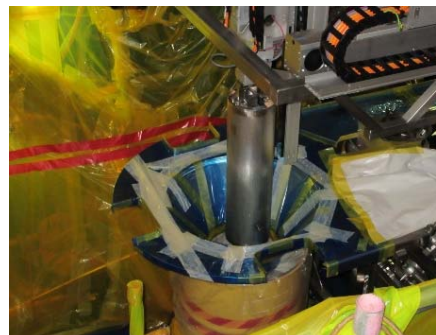

○ Other measures to reduce exposures

1. Utilization of area monitors

Twenty nine units of temporary area monitors were installed in the workplace and spent resin transfer pipe in advance to measure dose equivalent rates remotely for reducing radiation work under a high dose equivalent environment (measured results in 26).

2. Clear indication of waiting position

The waiting position in preparation of system decontamination work was designated to clearly show the position with a low dose equivalent rate so that workers could avoid unnecessary exposures during the waiting hours.

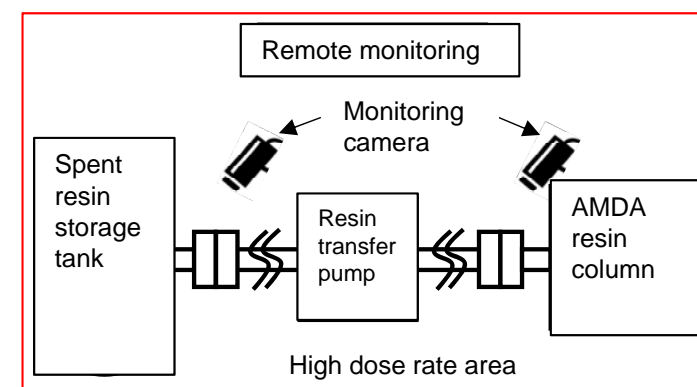

Reduction of Exposures (Other Measures ②)

Measurements by area monitor

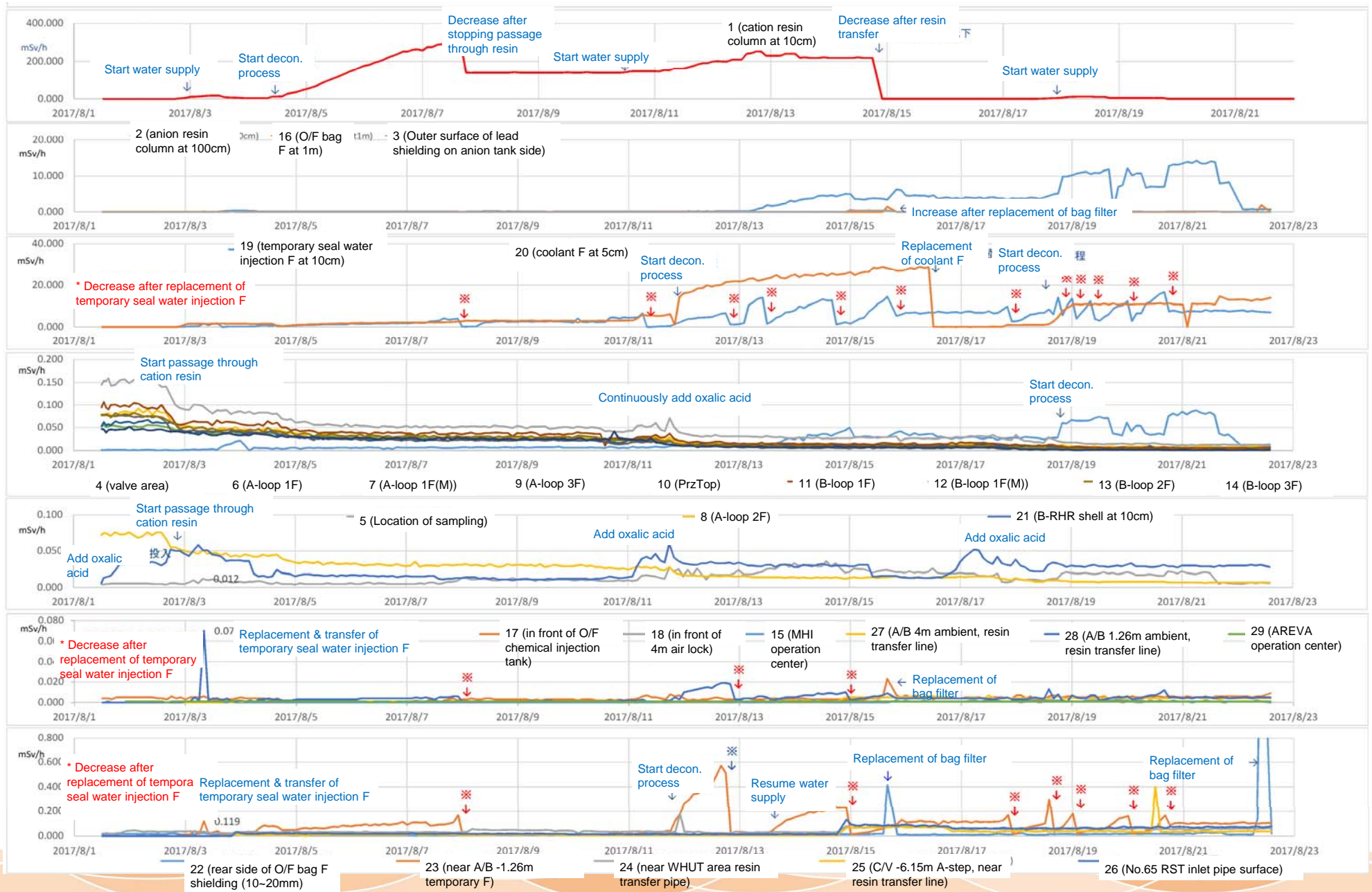

○ Leakage prevention measures

Curing enclosure and drain cut-off weir were installed and hoses were bound firmly to prevent highly concentrated, contaminated water from leaking during system decontamination work for the prevention of physical contamination.

1. Curing enclosure

Curing enclosure was provided around the pipe connections, including the valve casing, with heat resistant, water proof sheets to prevent contaminated water from spreading in case of leakage.

2. Drain cut-off weir

Drain cut-off weir was installed using heat resistant, water proof sheets around the facilities, which provided the flow path of circulating chemicals during decontamination work, and major equipment, such as the chemical injection system, having a high risk of leakage to prevent contaminated water from leaking.

3. Biding hoses

The hose connecting AMDA, which is assembled in the field with joints and thus preliminary pressure tests cannot be performed at shop, is bound firmly besides normal clamping to prevent the hose from coming off.

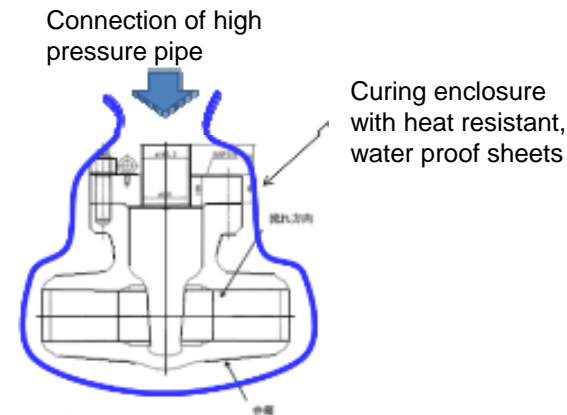

A weir having a height of approx. 150mm was installed using heat resistant, water proof sheets around the facilities, which provided the flow path of circulating chemicals during decontamination work, and major equipment, such as the chemical injection system, having a high risk of leakage to prevent contaminated water from leaking.

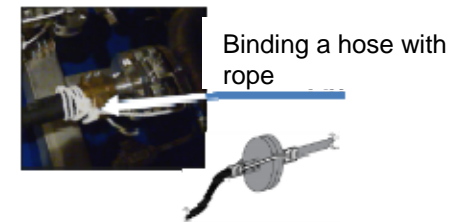

- Appropriate management of contamination control areas
The location where major equipment was installed was designated as the contamination control area to clearly differentiate it from general areas. Workers were required to change into yellow shoes and wear necessary protective devices, including rubber gloves, before entering the contamination control area to prevent physical contamination and contamination from spreading.
- Wearing of appropriate radiation protection devices
Workers were required to put on and off predetermined protective devices appropriately to prevent physical contamination since the replacement of bag filters and sampling of decontamination effluent involves work with contaminated work.
- Effective use of whole body contamination monitors
Whole body contamination monitors were installed in front of the air lock at EL 4m in the auxiliary building and in the passage at EL 4m in the auxiliary building respectively to check for physical contamination during work activities as appropriate so that potential contamination of workplace can be immediately identified and necessary countermeasures can be taken in the early stage to improve the working environment and prevent physical contamination.



Reduction of Radioactive Waste (Solid Waste)

○ Amount of resin used for decontamination

		Anion resin	Cation resin	Subtotal
Mihama 1	1 st cycle	150 L	300L	—
	2 nd cycle	300L	3,000L	—
	3 rd cycle	700L	1,400L	—
	Subtotal	1,150L	4,700L	5,850L
Mihama 2	1 st cycle	200L	1,400L	—
	2 nd cycle	400L	1,900L	—
	3 rd cycle	200L	2,100L	—
	4 th cycle	600L	1,800L	—
	Subtotal	1,400L	7,200L	8,600L
Total		2,550L	11,900L	14,450L

The total amount of resin used for the system decontamination amounted to 14.45m³, which was 1.4 times greater than expectation of 10.4m³. Such an increase is suspected to have been caused by a greater amount of Fe and Ni dissolved from the oxide film on the inner surface of the system than original expectation, which transferred to the system fluid in the form of oxides.

Gaseous waste

To reduce C-14 arising from the reaction with oxalic acid, which was injected to dissolve the metal (Fe, Ni, Co, etc.) contained in the oxide film on the inner surface of the system, radioactive gaseous waste generated from the system decontamination was diluted using the degassing system at a stage prior to releasing the gas via the auxiliary building vent stack and a temporary gas monitor was installed to enhance radiation monitoring. As a result, radioactivity of released gas was determined to be a non-detectable level (refer to the measurements by temporary gas monitor 31).

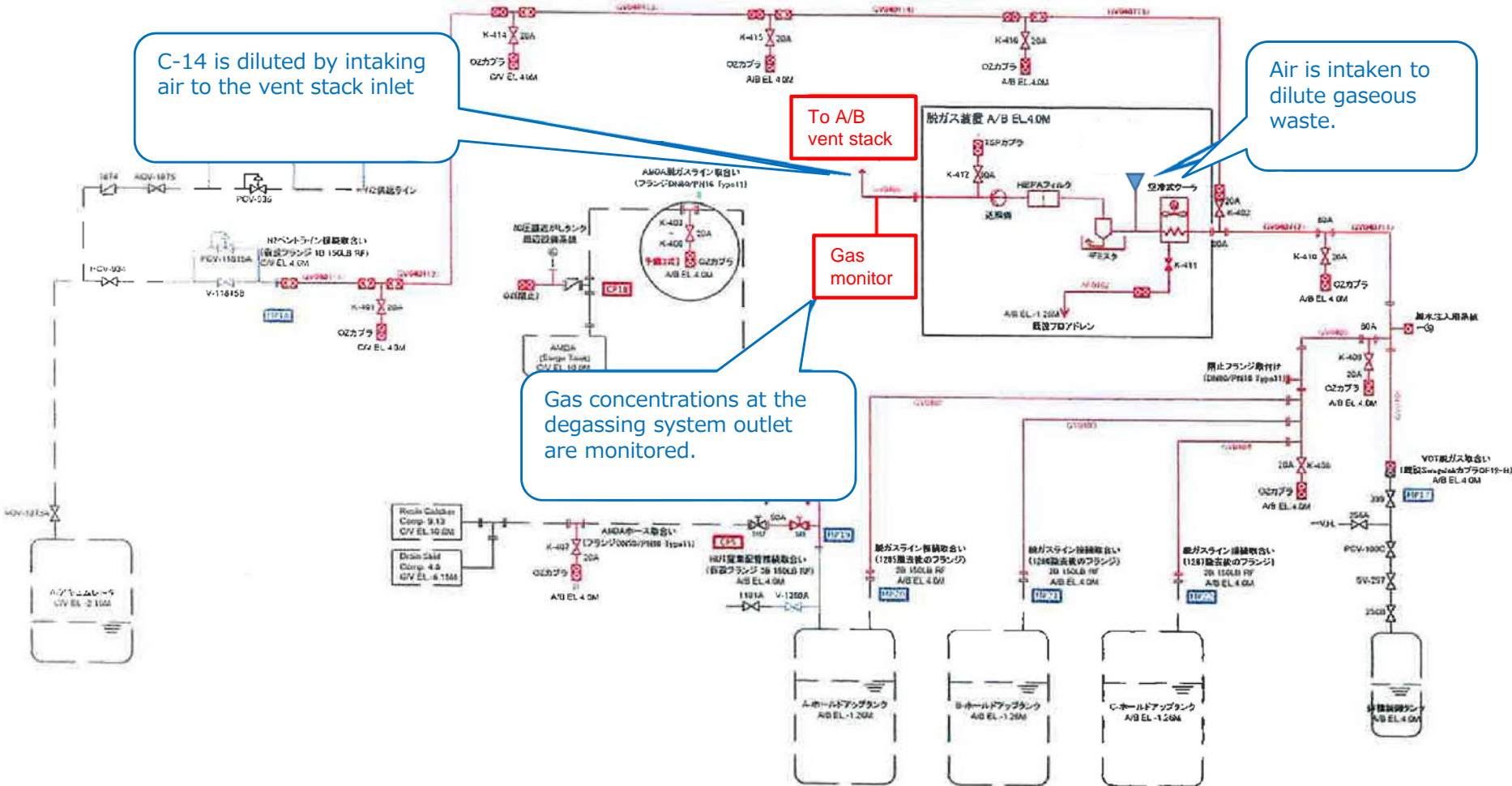

Reduction of Radioactive Waste (Gaseous Waste ②)

Measurements by temporary gas monitor

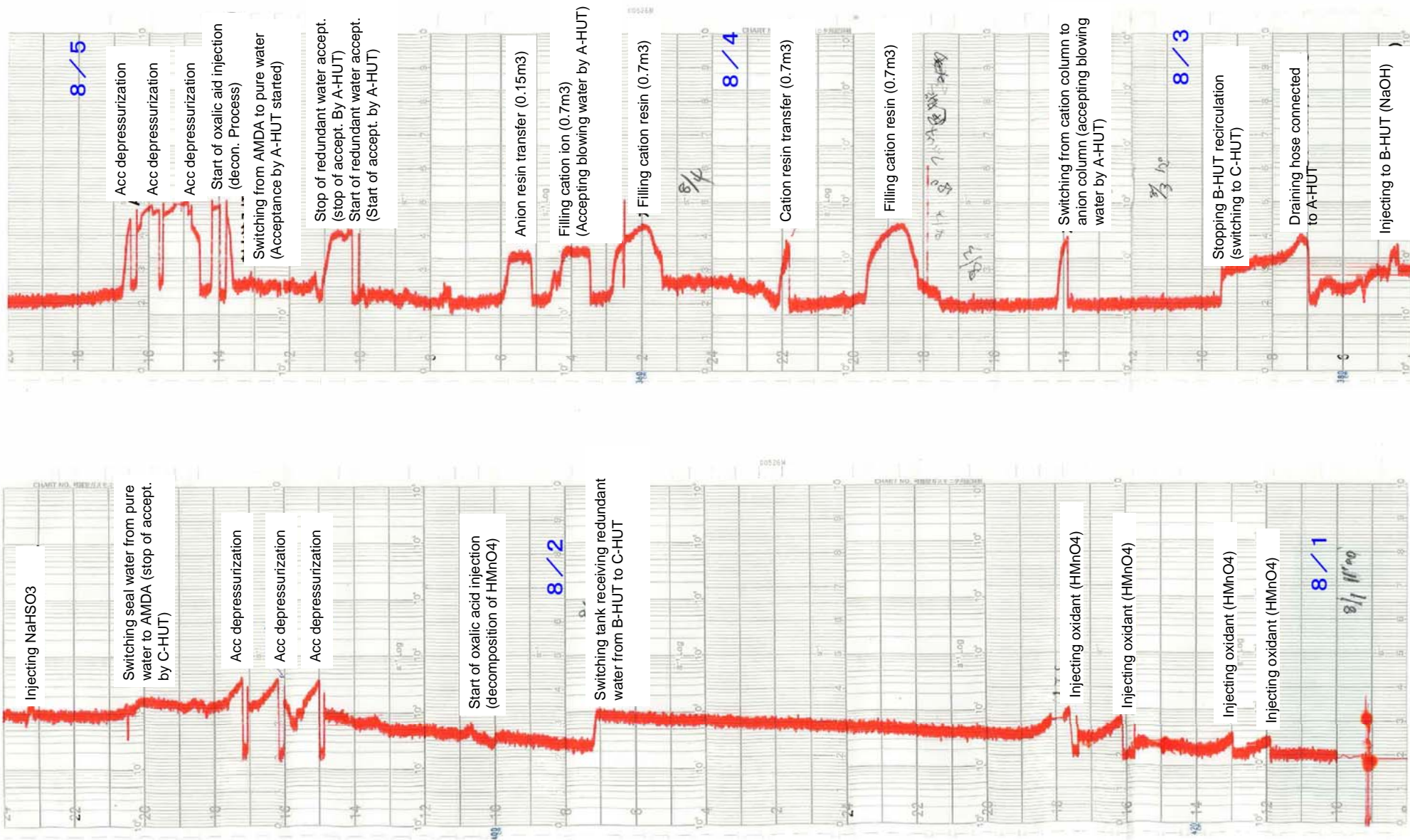

Results of radiological management efforts made during decontamination work

○ Reduction of exposures

With no experience of system decontamination, we had thorough preparation including the evaluation of dose equivalent rates in advance. In addition, temporary shielding was installed as much as possible to the necessary locations at unit 1. By referring to the application at unit 1, temporary shielding was installed at unit 2 as efficient as possible. By taking additional measures, including well-established access control, occupational exposures were successfully reduced.

○ Prevention of physical contamination

Physical contamination and internal exposure was successfully prevented by taking measures to prevent highly concentrated, contaminated water from leaking and designating and managing contamination control areas appropriately.

○ Reduction of radioactive waste

It is suspected that the amount of resin used for the system decontamination became larger since the amount of dissolved Fe and Ni was greater than expectation. C-14 was diluted before release and a temporary gas monitor was used while releasing gaseous waste. As a result, radioactivity of the released gas was determined to be a non-detectable level.

FIN

