

Application of the Most Appropriate Algorithm for Estimating Personal Dose of Radiation Workers during Maintenance Periods in NPPs

2014.09.23

Hee Geun Kim / Team Leader
Decommissioning Technology Team
Radiation & Environment Laboratory
Central Research Institute, KHNP



KOREA HYDRO & NUCLEAR POWER CO., LTD

Topics for Presentation

1. Effective Dose and Two Dosimeters

2. Two-Dosimeter Algorithms

3. ST Geometry and Application Test

4. Operational Experience

5. Effective Dose Based on ICRP 103

6. Extremity Dosimetry

Effective Dose and Two Dosimeters

Effective Dose and Two-Dosimeters

□ Effective Dose (E)

- Primary protection dose quantity.
 - H_E : ICRP-26 (1977), E : ICRP-60 (1991).
 - Provide “risk-based” radiation protection system.

- Not directly measurable.
$$E = \sum_T w_T H_T$$

- Measure radiation dose outside the body and convert it to E .

- After implementing the ICRP 60 since 2003 in Korea,
 - E system was fully adopted to the Korean atomic law.
 - Dose limit was the reduced: 50mSv/y → 100mSv/5y.
 - No margin for controlling the dose management.

Effective Dose and Two-Dosimeters

□ Effective Dose

- A single dosimeter on the chest :
 - $H_p(10) \rightarrow E$.
 - acceptable only for frontal incident radiations.
- If photon beam comes from the back or high?
 - severe underestimation (7-10 times).
 - ICRP-75 (1997) \rightarrow “dosimeter should be worn at an appropriate position on the body”
- How do we solve this problem?

Effective Dose and Two-Dosimeters

□ Approach of Two-Dosimeter

- Several investigators suggested using “two” dosimeters.
 - [Chest + Back] or [Chest + Head]
 - at least one dosimeter always directly exposed.
- NCRP-122 (1995) recommended using two dosimeters “for scenarios where the irradiation geometry or photon energy is unknown or difficult to characterize.”
- How do we combine these dosimeter readings for the best estimation of E?

Effective Dose and Two-Dosimeters

□ Combination of Two-Dosimeter

- The best combination of dosimeter weighting factors are the various values for the **chest and back dosimeters** or the chest and head dosimeters.
- **Underestimation problem** for posterior incident radiation was completely avoided by using two dosimeters and the developed algorithm.
- **Overestimation problem** does exist for typical beam directions, but significantly decreases in real situations.

Effective Dose and Two-Dosimeters

□ Previous Two-Dosimeter Practices in Korea

- Radiation protection program for two-TLD dosimetry
→ Procedure of external dosimetry or dose assessment
- Maintenance of steam generator (SG), reactor coolant pump (RCP), reactor head internal (RHI) and PZR heater replacement
- Wearing the two-dosimeter at chest and head area
- $H_p(10)_{\text{maximum}} \rightarrow E$ (No application of the two-dosimeter algorithm and overestimation of effective dose)
- The issued conditions of two-dosimeter were based on the INPO Guideline [Guidelines for RP at NPPs (INPO 91-014; 1995)]

Two-Dosimeter Algorithms

Two-Dosimeter Algorithms



□ Dose measurement of E inside Steam Generator

- Estimating E in a S/G channel head is not easy.
 - ☞ non-uniform, high gradient and depends on many factors
(Few mSv/h ~ 5×10^2 mSv/h)
- Single-dosimeter approach (chest or head) not accepted as an appropriate approach.
- Many dosimeters: the highest dosimeter response.
- But many disadvantages:
 - expensive and complex
 - overly conservative
 - difficult to relate recorded dose to health risk
 - uncertainties in the future epidemiological studies

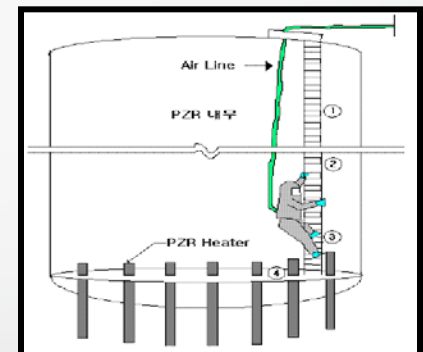
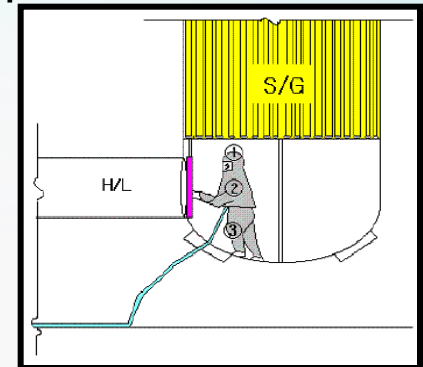

Two-Dosimeter Algorithms



□ According to Previous Studies or Papers

- Single-dosimeter approach significantly underestimates the E in some exposure situations.
- Two-dosimeter approach does not underestimate the E by more than 5%.
- Six two-dosimeter algorithms have specific technical bases
 - Two dosimeter readout: chest/head or chest/back
 - Specific weighting factor
 - Solid and specific technical background
 - Application high radiation field (ex, SG chamber)

Two-Dosimeter Algorithms



□ 6 Algorithms Based on Previous Investigations

1. ANSI N13.41 (1997) Algorithm
2. NCRP(70/30) Algorithm (NCRP-122; 1995)
3. NCRP(55/50) Algorithm (NCRP-122; 1995)
4. EPRI Algorithm (NRC RIS 2004-1)
5. Lakshmanan Algorithm (1991)
6. Kim(58/42) Algorithm (1999)

☞ **Which algorithm is the best or the more appropriate for estimating the effective dose?**

Two-Dosimeter Algorithms



- ANSI N13.41 (1997) Algorithm;

$$H_E = \sum W_c H_{p,c}(10) = 0.10 H_{p,\text{head and neck}}(10) + 0.90 H_{p,\text{rest}}(10)$$

- NCRP(70/30) Algorithm (1995);

$$H_E(\text{estimate}) = 0.7 H_p(10)_{\text{front}} + 0.3 H_p(10)_{\text{back}}$$

- NCRP(55/50) Algorithm (1995);

$$H_E(\text{estimate}) = 0.55 H_p(10)_{\text{front}} + 0.50 H_p(10)_{\text{back}}$$

Two-Dosimeter Algorithms



- EPRI Algorithm; US NRC, RIS 2004-01;

$$H_E(\text{estimate}) = \frac{H_p(10)_{\text{max. of front or back}} + H_p(10)_{\text{avg. of front and back}}}{2}$$

- Lakshmanan Algorithm (1991);

$$H_E(\text{estimate}) = \frac{H_p(10)_{\text{front}} + H_p(10)_{\text{back}}}{1.5}$$

- Kim Algorithm (1998);

$$H_E(\text{estimate}) = h(H_E) [0.58 H_P(10)_{\text{front}} + 0.42 H_P(10)_{\text{back}}]$$

$$\text{where } h(H_E) = \frac{0.9 H_E(\text{AP})}{0.58 H_f(\text{AP}) + 0.42 H_b(\text{AP})} \cong 1.02$$

Source Term Geometry and Application Test

ST Geometry and Application Test



□ Steam Generator General

- Combustion engineering type S/G
- Radiation field in a S/G channel head depends on many factors.
- However, dominated by ^{60}Co and ^{58}Co (~95%).
- Source term and photon field from **upper U tubes**.
- Dose rate is **non-uniform** and gradient from **high to low**.
(Few mSv/h ~ 5×10^2 mSv/h)
- Dose rate exceeds **few mSv/hr (\geq)** and very high gradient of the chest by more than **50%**

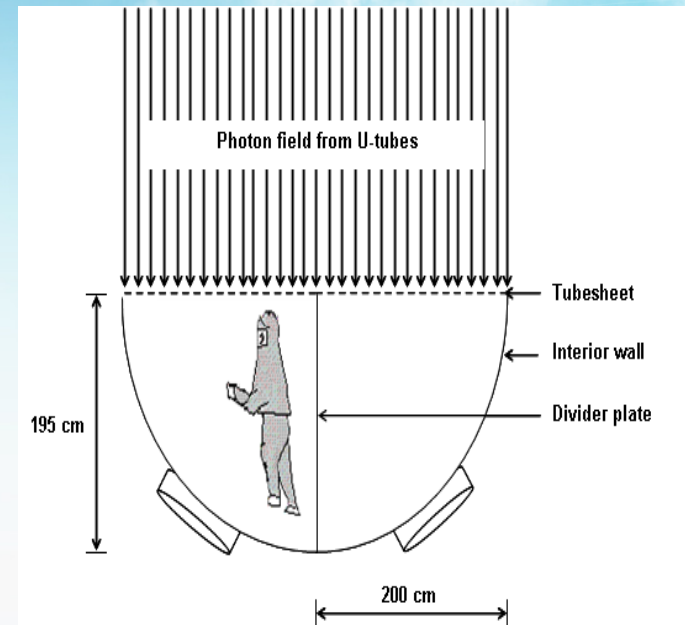

ST Geometry and Application Test



□ Steam Generator Geometry

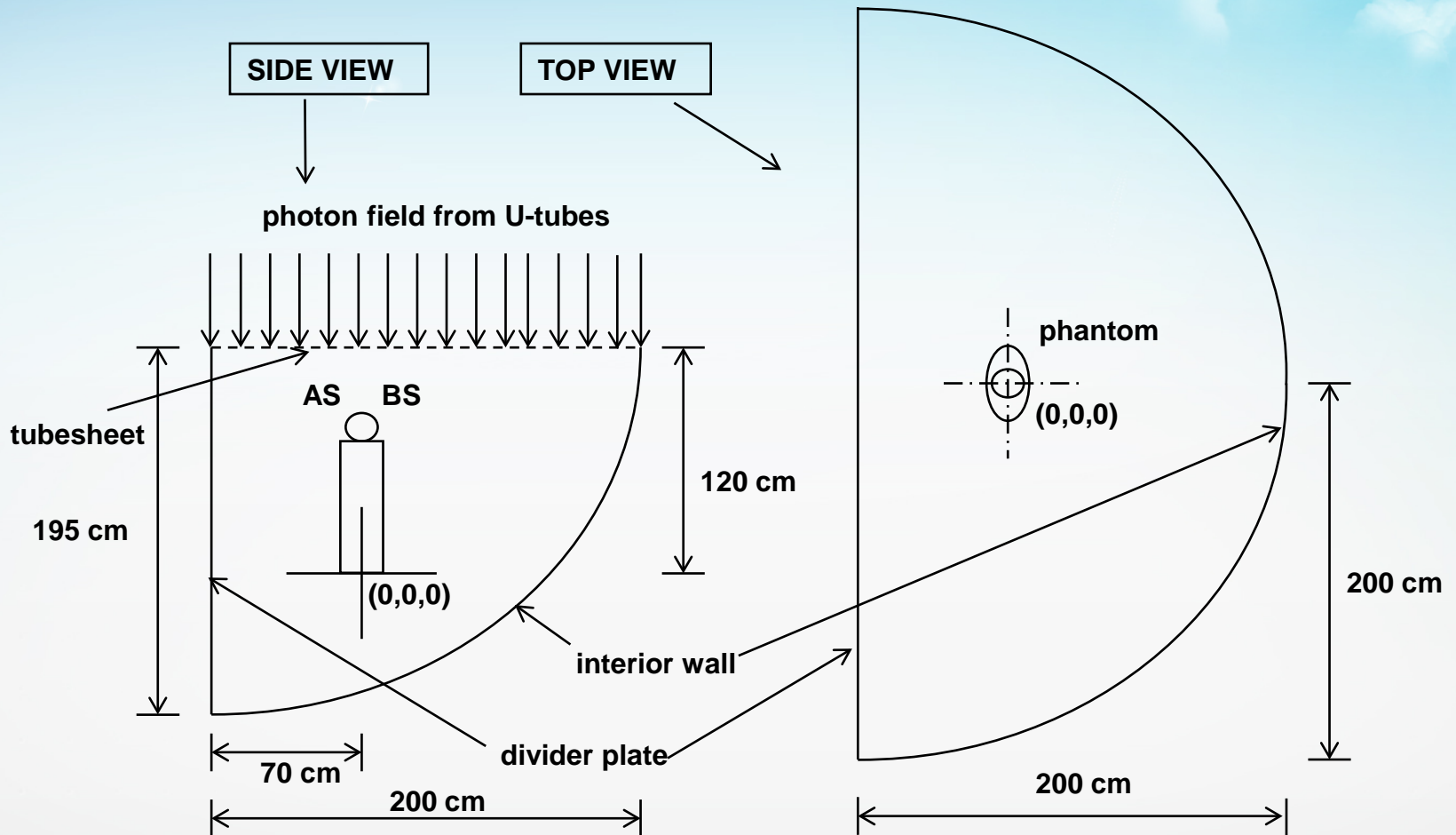

ST Geometry and Application Test



Potential radionuclide typically detected at pressurized water reactors

Category	Radionuclides
Activation Products	^3H , ^{54}Mn , ^{55}Fe , ^{57}Co , ^{58}Co , ^{60}Co , ^{63}Ni , ^{65}Zn , $^{110}\text{Ag}^m$, ^{124}Sb , ^{125}Sb , ^{152}Eu , ^{154}Eu
Fission Products	^{90}Sr , $^{95}\text{Zr/Nb}$, $^{106}\text{Ru/Rh}$, ^{134}Cs , ^{137}Cs
Other	^{234}U , ^{235}U , ^{238}U , ^{239}Pu

Reference : Radiation Protection at Nuclear Reactors (Health Physics Society), 1995.

Table 1. Radiation field characteristics for Korean NPPs.

Radiation types	Counting systems	Measured areas	Status of reactor operation	Number of measuring points	Average energy (keV) or main radionuclides
Gamma	Portable HPGe detector	Reactor building	Shutdown	8	436.8–783.6
		Auxiliary building	Normal operation	7	346.7–715.8
		Auxiliary building	Normal operation	7	279.9–803.7
Neutron	BMSS	Reactor building	Normal operation	5	17.3–206.4
Beta	Si semi-conductor detector	Reactor building	Shutdown	6	^{60}Co
		Auxiliary building	Shutdown	8	^{60}Co

ST Geometry and Application Test



- Application Test for TDA during Maintenance Periods
 - Algorithm considered : 6 algorithms
 - Pilot plant : Yonggwang unit 4 and Ulchin unit 4 (CE type reactor)
 - Target work : S/G, PZR heater replacement and reactor head internal
 - Application test :
 - Review the two-dosimeter characteristics : **common**, MC simulation, application situation, technical background, convenience...
 - Fully explain the necessity of pilot test to the workers
 - **3 TLDs and 3 ADRs** provided to radiation workers wearing at **head, chest and back** simultaneously.
 - The **effective dose (E)** are calculated based on **Hp(10) of 2 TLDs** readouts for the purpose of the adoption of two-dosimeter algorithm.
 - E is analyzed and sorted for searching of algorithm trend analysis from high effective dose to low E.

ST Geometry and Application Test



Table 1. TLD and ADR readouts for the installation of a steam generator nozzle dam at Yonggwang NPP No. 2.

User ^a	TLD readout (mSv)			ADR readout (mSv)		
	Head	Chest	Back	Head	Chest	Back
A	4.25	2.96	3.68	4.47	3.36	4.03
B	2.60	2.09	2.71	2.85	2.25	2.99
C	2.41	1.90	2.13	2.65	1.97	2.57
D	2.29	1.57	2.07	2.68	1.93	2.37
E	3.57	2.73	3.69	4.02	2.94	4.16
F	2.73	1.80	2.25	2.87	1.99	2.75
G	3.51	2.62	3.02	4.03	2.68	3.65
H	2.00	1.75	2.00	2.23	1.79	2.18
I	2.19	1.81	2.09	2.53	1.90	2.42
J	1.93	1.71	2.04	2.26	1.87	2.30
K	2.34	1.71	2.24	2.56	1.77	2.42
L	1.82	1.52	1.86	2.06	1.61	2.17
M	2.02	1.50	1.97	2.28	1.73	2.21
N	4.22	3.64	4.66	4.88	3.71	5.83
O	2.21	1.69	2.11	2.50	1.84	2.43
P	1.88	1.44	1.85	2.30	1.50	2.17
Q	1.31	0.96	1.18	1.44	0.99	1.45
R	0.73	0.48	0.65	0.74	0.51	0.71
S	1.23	0.92	1.00	1.44	0.97	1.19
T	0.76	0.54	0.65	0.85	0.61	0.77
U	1.51	1.00	0.34	1.69	0.80	0.50
V	0.00	0.10	0.00	0.08	0.12	0.08
W	0.12	0.18	0.08	0.19	0.24	0.13
X	0.12	0.11	0.00	0.17	0.15	0.11
Y	0.11	0.13	0.00	0.15	0.12	0.10
Z	0.12	0.15	0.13	0.19	0.20	0.16

^a‘User’ indicates the radiation workers (26 persons) who participated in the installation of a steam generator nozzle dam at Yonggwang NPP No. 2.

ST Geometry and Application Test



Table 2. TLD and ADR readouts for the removal of a steam generator nozzle dam at Yonggwang NPP No. 2.

User ^{a,b}	TLD readout (mSv)			ADR readout (mSv)		
	Head	Chest	Back	Head	Chest	Back
A	1.82	1.50	1.64	1.99	1.61	2.09
B	1.76	1.58	1.68	1.98	1.66	1.96
C	1.68	1.24	1.48	2.02	1.38	1.84
D	1.75	1.27	1.60	1.93	1.49	1.87
E	2.01	1.48	1.68	2.25	1.50	1.97
F	1.69	1.49	1.60	1.88	1.61	1.93
G	1.52	1.13	1.31	1.68	1.49	1.21
H	1.69	1.30	1.57	1.96	1.56	1.98
I	1.22	0.81	0.92	1.37	0.91	1.06
J	2.32	1.79	1.98	2.89	1.90	2.40
K	0.00	0.00	0.00	0.05	0.06	0.04
L	0.00	0.00	0.00	0.06	0.06	0.05
M	0.09	0.09	0.00	0.09	0.11	0.07
N	0.00	0.00	0.00	0.04	0.04	0.04
O	0.00	0.00	0.00	0.07	0.08	0.06
P	0.14	0.12	0.00	0.15	0.12	0.09

^a‘User’ indicates the radiation workers (16 persons) who participated in the removal of a steam generator nozzle dam at Yonggwang NPP No. 2.

^bUsers in Table 2 are different from those in Table 1. However, some workers who participated in the installation of a steam generator nozzle dam, and who were exposed to low effective dose equivalents, also took part in the removal of the steam generator nozzle dam.

ST Geometry and Application Test



Table 3. Calculated effective dose equivalents from the installation of a steam generator nozzle dam at Yonggwang NPP No. 2.

No. of TLD wearers ^a	Effective dose equivalent (mSv)						
	Maximum ^b	ANSI	NCRP (70:30)	NCRP (55:50)	EPRI (Xu)	Lakshmanan	Kim
1	4.66	3.70	3.95	4.33	4.41	5.53	4.27
2	4.25	3.09	3.18	3.47	3.50	4.43	3.43
3	3.69	2.81	3.02	3.35	3.45	4.28	3.29
4	3.51	2.71	2.74	2.95	2.92	3.76	2.93
5	2.73	1.89	1.94	2.12	2.14	2.70	2.09
6	2.71	2.14	2.28	2.50	2.56	3.20	2.47
7	2.41	1.95	1.97	2.11	2.07	2.69	2.10
8	2.34	1.77	1.87	2.06	2.11	2.63	2.03
9	2.29	1.64	1.72	1.90	1.95	2.43	1.87
10	2.21	1.74	1.82	1.98	2.01	2.53	1.96
11	2.19	1.85	1.89	2.04	2.02	2.60	2.02
12	2.04	1.73	1.81	1.96	1.96	2.50	1.94
13	2.02	1.55	1.64	1.81	1.85	2.31	1.78
14	2.00	1.78	1.83	1.96	1.94	2.50	1.95
15	1.88	1.48	1.56	1.72	1.75	2.19	1.69
16	1.86	1.55	1.62	1.77	1.78	2.25	1.75
17	1.51	1.05	0.80	0.72	0.84	0.89	0.76
18	1.31	1.00	1.03	1.12	1.13	1.43	1.11
19	1.23	0.95	0.94	1.01	0.98	1.28	1.00
20	0.76	0.56	0.57	0.62	0.62	0.79	0.62
21	0.73	0.51	0.53	0.59	0.61	0.75	0.58
22	0.18	0.17	0.15	0.14	0.16	0.17	0.14
23	0.15	0.15	0.14	0.15	0.15	0.19	0.15
24	0.13	0.13	0.09	0.07	0.10	0.09	0.08
25	0.12	0.11	0.08	0.06	0.08	0.07	0.07
26	0.10	0.09	0.07	0.06	0.08	0.07	0.06

^a‘No. of TLD wearers’ indicates the radiation workers (26 persons) who participated in the installation of a steam generator nozzle dam at Yonggwang NPP No. 2.

^b‘Maximum’ indicates the maximum TLD readout from the head, chest or back.

ST Geometry and Application Test



Table 4. Calculated effective dose equivalents from the removal of a steam generator nozzle dam at Yonggwang NPP No. 2.

No. of TLD wearers ^a	Effective dose equivalent (mSv)						
	Maximum ^b	ANSI	NCRP (70:30)	NCRP (55:50)	EPRI (Xu)	Lakshmanan	Kim
1	2.32	1.84	1.85	1.97	1.93	2.51	1.96
2	2.01	1.53	1.54	1.65	1.63	2.11	1.64
3	1.82	1.53	1.54	1.65	1.61	2.09	1.64
4	1.76	1.60	1.61	1.71	1.66	2.17	1.70
5	1.75	1.32	1.37	1.50	1.52	1.91	1.48
6	1.69	1.51	1.52	1.62	1.57	2.06	1.61
7	1.69	1.34	1.38	1.50	1.50	1.91	1.48
8	1.68	1.28	1.31	1.42	1.42	1.81	1.41
9	1.52	1.17	1.18	1.28	1.27	1.63	1.27
10	1.22	0.85	0.84	0.91	0.89	1.15	0.90
11	0.14	0.12	0.08	0.07	0.09	0.08	0.07
12	0.09	0.09	0.06	0.05	0.07	0.06	0.05
13	0.00	0.00	0.00	0.00	0.00	0.00	0.00
14	0.00	0.00	0.00	0.00	0.00	0.00	0.00
15	0.00	0.00	0.00	0.00	0.00	0.00	0.00
16	0.00	0.00	0.00	0.00	0.00	0.00	0.00

^aNo. of TLD wearers' indicates the radiation workers (16 persons) who participated in the removal of a steam generator nozzle dam at Yonggwang NPP No. 2.

^b'Maximum' indicates the maximum TLD readouts from the head, chest or back.

ST Geometry and Application Test

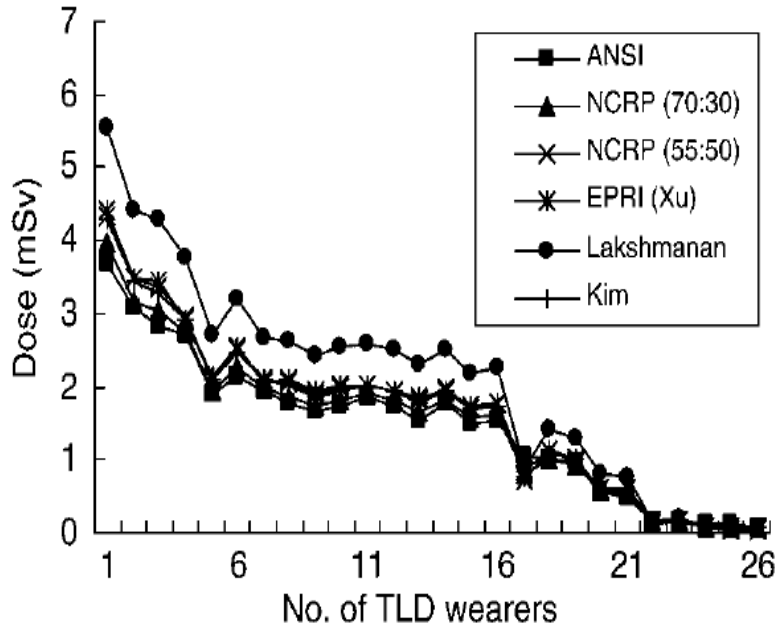

Figure 2. Application of a two-dosemeter algorithm for the installation of a steam generator nozzle dam at Yonggwang NPP No. 2. 'No. of TLD wearers' indicates the total number of radiation workers (26 persons) who participated in the installation of a steam generator nozzle dam at Yonggwang NPP No. 2, which is also referred to in Table 3. The results are displayed from high to low effective dose equivalent using 6 two-dosemeter algorithms based on TLD readouts from the head and chest or from the chest and back.

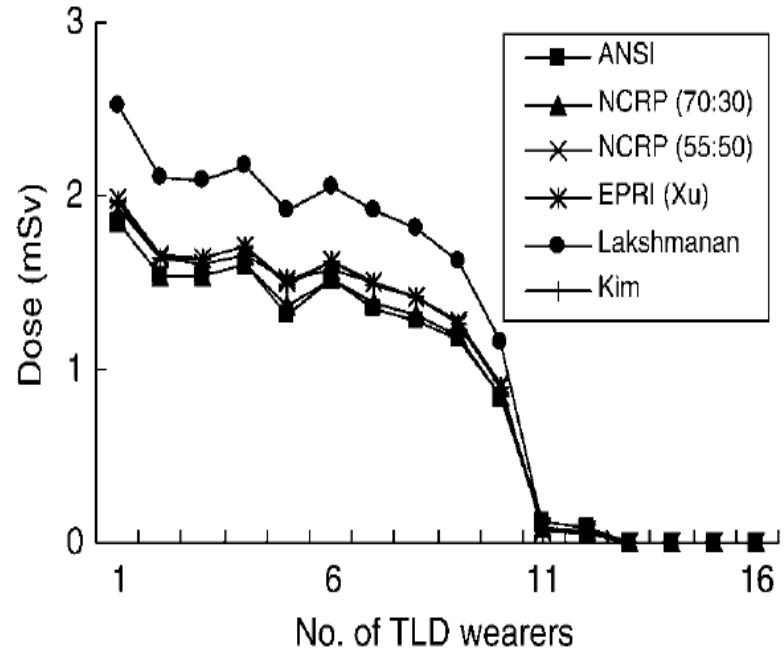

Figure 3. Application of a two-dosemeter algorithm for the removal of a steam generator nozzle dam at Yonggwang NPP No. 2. 'No. of TLD wearers' indicates the total number of radiation workers (16 persons) who participated in the removal of a steam generator nozzle dam at Yonggwang NPP No. 2, which is also referred to in Table 4. The results are displayed from high to low effective dose equivalent using 6 two-dosemeter algorithms based on TLD readouts from the head and chest or from the chest and back.

ST Geometry and Application Test



- Review before test: Level of NPP radiation work, margin for controlling the dose, source term geometry(radiation field), TDA common characteristics, EDE and E, etc.
- Cooperation with HP: Pre-explanation for test necessity to workers, 3 TLDs and 3 ADRs provided to workers, TLD readout and dose tracking(time, TLD/ADR dose response).
- Set up the issuing conditions for two dosimeters: Difference in expected equivalent dose $\geq 30\%$, or dose rate gradients 1mSv/h and 10% of dose limit (2mSv/task).

ST Geometry and Application Test



- Calculation and analysis: EDE/E calculation, sorting from high to low dose, conservatism, consulting with MC expert, dose trend, technical BKG and authority, etc.
- Working quality and convenience (by interview): Workers reacted positively to wearing TLD on the chest and back.
- EDE/E were calculated based on TDAs were ~10-30% lower than that of the highest TLD readout.
- Selected TDA, NCRP(55/50) algorithm, was reflected in NPP procedure at the end of 2005.

Operational Experience

Operational Experience

👉 Implemented to all KNPPs since 2005

☐ Example 1: Installation of a SG nozzle dam at the Kori NPP No. 1

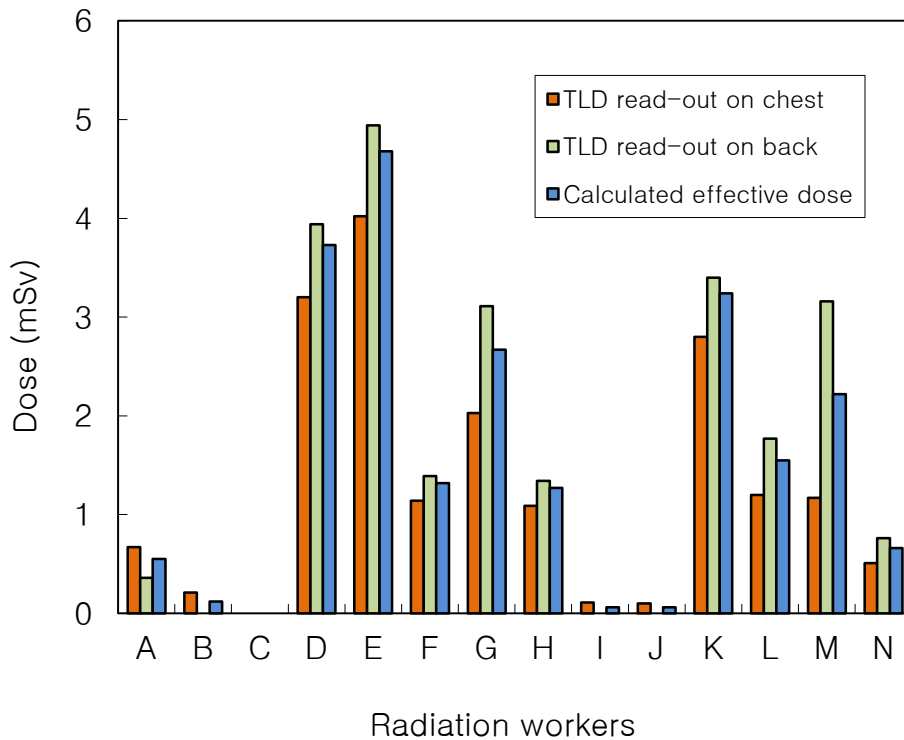

TLD Readouts

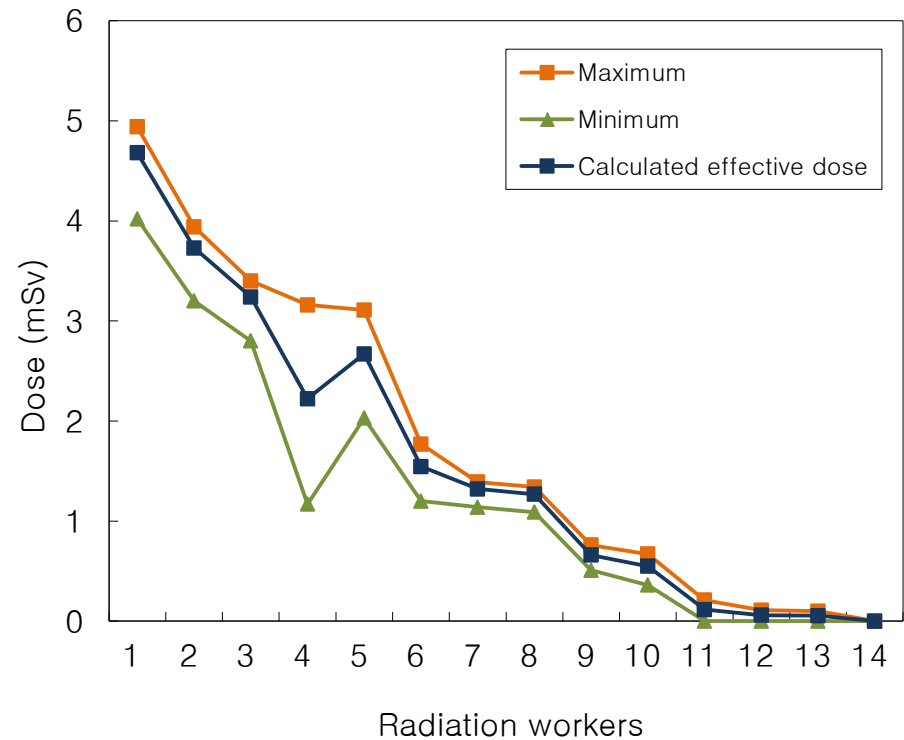

Comparison of Effective Dose

Operational Experience

Example 2: Penetration Test of a Reactor Head at the Kori NPP No. 1

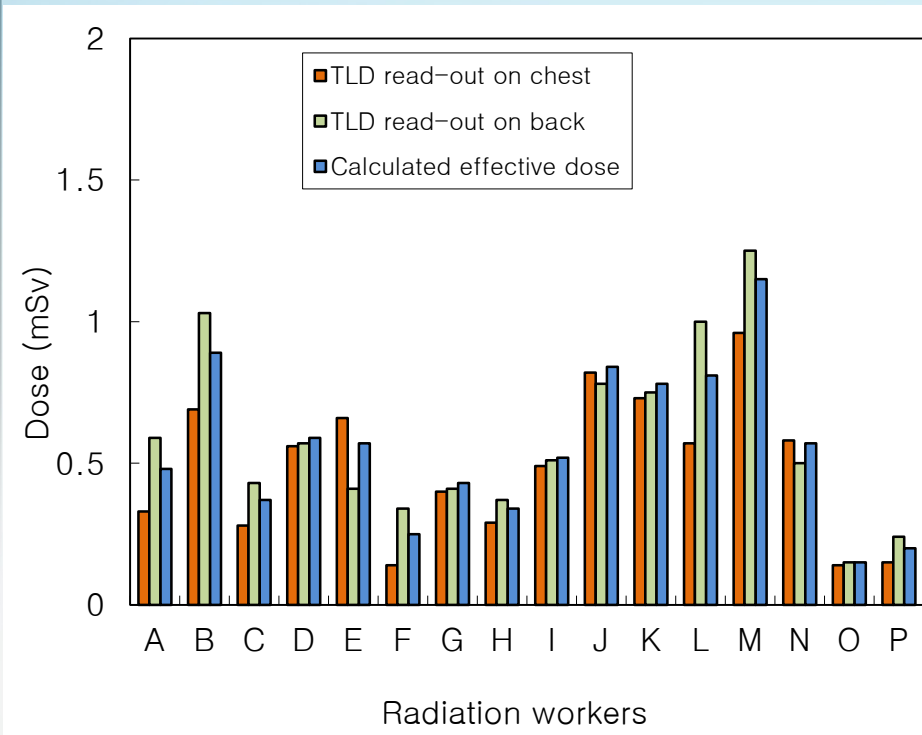

TLD Readouts

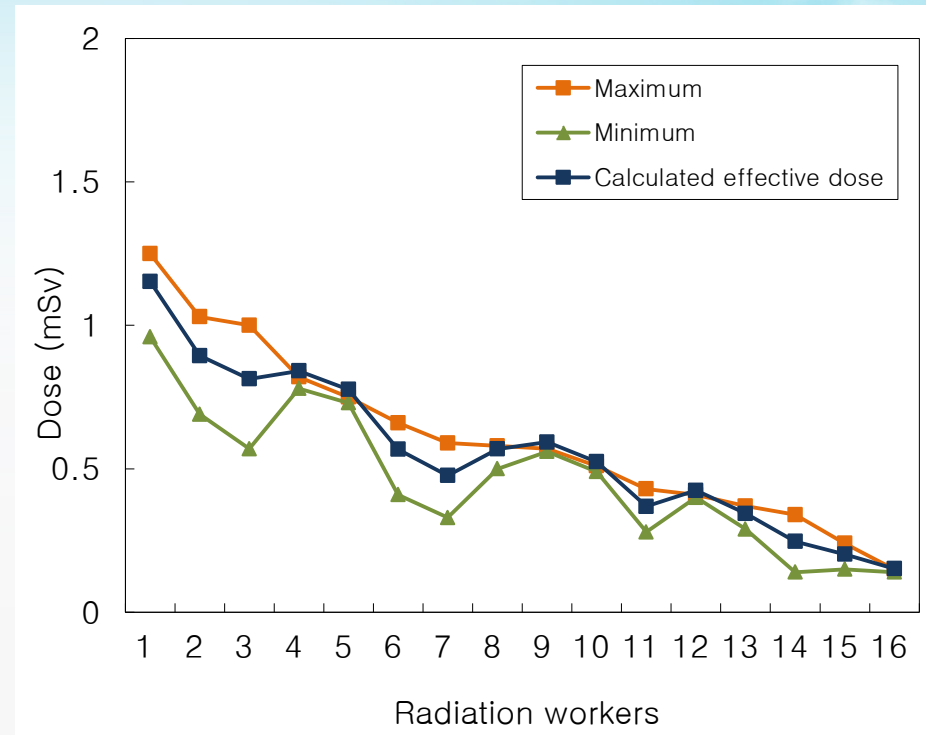

Comparison of Effective Dose

Operational Experience



Table 2. Summary of Dose Distribution and Difference.

NPP	Items of Radiation Work	General Trend of Dose Distribution ^a	Dose Difference ^b
Kori No. 1	Installation of Steam Generator Nozzle Dam	Chest < E < Back	10–30%
Kori No. 1	Penetration Test of a Reactor Head	Chest < E < Back	5–15%
Yonggwang No. 1	Installation of Steam Generator Nozzle Dam	Chest < E < Back	10–30%
Yonggwang No. 1	Plugging and Nozzle Dam Removal	Chest < E < Back	10–30%
Wolsong No. 1	Ultrasonic Test of Feeder Pipe	Back < E < Chest	5–15%

^aChest = TLD readout on the chest, back = TLD readout on the back, E = calculated effective dose

^bDose difference = (maximum dose on the chest or back – minimum dose on the chest or back) / calculated effective dose

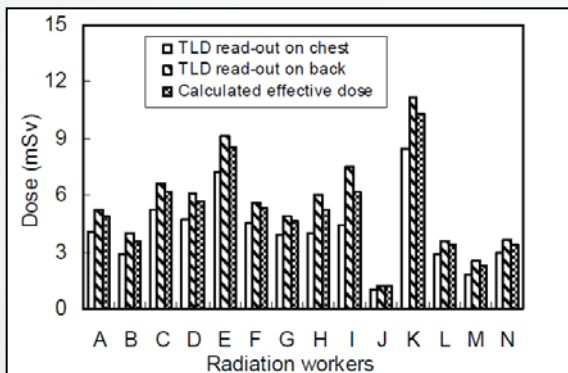

Fig. 4. TLD readouts for the installation of a steam generator nozzle dam at Yonggwang NPP No. 1.

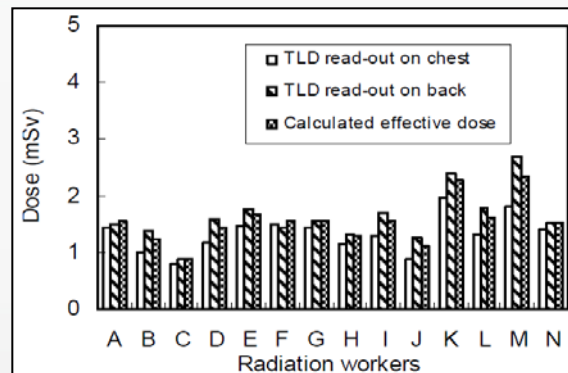

Fig. 5. TLD readouts for the plugging and nozzle dam removal of steam generator at Yonggwang NPP No. 1.

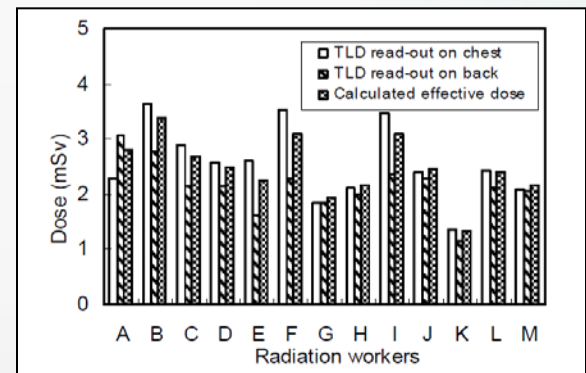

Fig. 6. TLD readouts for the ultrasonic test of feeder pipe at Wolsong NPP No. 1.

Effective Dose Calculation Based on ICRP 103 Publication

E Calculation Based on ICRP 103



Fig. 1. Voxel phantoms (Rex and Regina) of ICRP 103.

Kim's Two-Dosimeter Algorithms based on ICRP103
(Health Physics, 2011;100(5);462-467)

$$E(\text{estimate}) = h(E)[w \cdot R_f + (1-w) \cdot R_b] = 1.04(0.6R_f + 0.4R_b) = 0.62R_f + 0.42 R_b$$

Table 1. Tissue Weighting Factors of ICRP 103.

Tissues	Weighting factors	Sum
Bone marrow (red), Colon, Lung, Stomach, Breasts, Remainder*	0.12	0.72
Gonads	0.08	0.08
Bladder, Oesophagus, Liver, Thyroid	0.04	0.16
Bone surfaces, Brain, Salivary glands, Skin	0.01	0.04
	Total	1.0

* Remainder: adrenals, extrathoracic tissue, gall bladder, heart wall, kidneys, lymph nodes, muscle, oral mucosa, pancreas, prostate, small intestine, spleen, thymus, uterus/cervix

Table 2. Radiation Weighting Factors of ICRP 103.

Radiation type	Weighting factors
Photons	1
Electrons ⁺ and muons	1
Protons and charged pions	2
Alpha particles, fission fragments, heavy ions	20
Neutrons	A continuous function of neutron energy

All values relate to the radiation incident on the body or, for internal radiation sources, emitted from the incorporated radionuclide(s).

E Calculation Based on ICRP 103



Table 3. TLD Readouts of Field Tests in 2004-2005 (Installation of a Steam Generator Nozzle Dam at Yonggwang NPPs Unit 4 During the Maintenance Period).

Personal Name	TLD Readout (mSv) [*]			ADR Readout (mSv) [†]		
	Head	Chest	Back	Head	Chest	Back
A	4.25	2.96	3.68	4.47	3.36	4.03
B	2.60	2.09	2.71	2.85	2.25	2.99
C	2.41	1.90	2.13	2.65	1.97	2.57
D	2.29	1.57	2.07	2.68	1.93	2.37
E	3.57	2.73	3.69	4.02	2.94	4.16
F	2.73	1.80	2.25	2.87	1.99	2.75
G	3.51	2.62	3.02	4.03	2.68	3.65
H	2.00	1.75	2.00	2.23	1.79	2.18
I	2.19	1.81	2.09	2.53	1.90	2.42
J	1.93	1.71	2.04	2.26	1.87	2.30
K	2.34	1.71	2.24	2.56	1.77	2.42
L	1.82	1.52	1.86	2.06	1.61	2.17
M	2.02	1.50	1.97	2.28	1.73	2.21

^{*} TLD: Thermoluminescent Dosimeter

[†] ADR: Auto Dosimetric Reader

- TDA implementation reduces the overestimation and prevents the underestimation of E.
- Calculated E was lower than the max. dose by approx. 10-30%.
- Increased convenience from the head and chest to head and back.

Table 4. Comparison of calculated EDE and E Based on the TLD Readouts of Field Tests in 2004-2005 (Installation of a Steam Generator Nozzle Dam at Yonggwang NPPs Unit 4 During the Maintenance Period).

Personal Name	TLD Readout (mSv)			EDE [*] or E [†] (mSv)		
	Head	Chest	Back	Maximum Dose	NCRP(55:50) TDA(EDE)	Kim TDA (2011) (E)
A	4.25	2.96	3.68	4.25	3.47	3.38
B	2.60	2.09	2.71	2.71	2.50	2.43
C	2.41	1.90	2.13	2.41	2.11	2.07
D	2.29	1.57	2.07	2.29	1.90	1.84
E	3.57	2.73	3.69	3.69	3.35	3.24
F	2.73	1.80	2.25	2.73	2.12	2.06
G	3.51	2.62	3.02	3.51	2.95	2.89
H	2.00	1.75	2.00	2.00	1.96	1.92
I	2.19	1.81	2.09	2.19	2.04	2.00
J	1.93	1.71	2.04	2.04	1.96	1.92
K	2.34	1.71	2.24	2.34	2.06	2.00
L	1.82	1.52	1.86	1.86	1.77	1.72
M	2.02	1.50	1.97	2.02	1.81	1.76

^{*} EDE: Effective Dose Equivalent

[†] E: Effective Dose based on ICRP 103

E Calculation Based on ICRP 103



Table 5. Comparison of calculated EDE and E Based on the TLD Readouts of Field Tests in 2006-2007 (Installation of a Steam Generator Nozzle Dam at Ulchin Units 1 & 2).

Personal Name	TLD Readout (mSv)		EDE [*] or E [†] (mSv)	
	Chest	Back	NCRP(55:50) TDA(EDE)	Kim TDA (2011) (E)
a	4.68	5.94	5.54	5.40
b	2.39	2.92	2.77	2.71
c	2.80	3.59	3.34	3.24
d	2.49	3.22	2.98	2.90
e	2.60	3.63	3.25	3.14
f	1.01	1.35	1.23	1.19
g	3.15	4.21	3.84	3.72
h	3.77	5.16	4.65	4.50
i	2.84	3.51	3.32	3.23
j	0.96	1.21	1.13	1.10
k	4.93	6.89	6.16	5.95
l	4.51			
m	2.01			

Table 6. Comparison of calculated EDE and E Based on the TLD Readouts of Field Tests in 2007 (UT Tests of Coolant Tube Nozzle at Wolsong Unit 1).

Personal Name	TLD Readout (mSv)		EDE [*] or E [†] (mSv)	
	Chest	Back	NCRP(55:50) TDA(EDE)	Kim TDA (2011) (E)
1	2.29	3.07	2.80	2.71
2	3.63	2.77	3.39	3.41
3	2.90	2.15	2.68	2.70
4	2.58	2.15	2.50	2.50
5	2.59	1.63	2.24	2.29
6	3.53	2.29	3.09	3.15
7	1.84	1.85	1.94	1.92
8	2.10	1.99	2.16	2.14
9	3.48	2.36	3.09	3.15
10	2.39	2.28	2.45	2.44
11	1.37	1.16	1.33	1.33
12	2.43	2.12	2.40	2.40
13	2.09	2.06	2.18	2.16

* EDE: Effective Dose Equivalent

† E: Effective Dose based on ICRP 103

* EDE: Effective Dose Equivalent

† E: Effective Dose based on ICRP 103

Extremity Dosimetry

Extremity Dosimetry



- Worker's hands would received the highest radiation doses because of their contact with the radioactive materials.
- Field test for extremity dose assessment undertaking contact tasks with high radiation dose were conducted.
- Characteristics of radiation fields in NPPs were analyzed to estimate the extremity dose.
- The incident radiation fields were analyzed using TLD readouts during maintenance period.
- Radiation workers were required to wear **two TLDs on the their chests and backs, a TLD on the wrist and an extremity dosimeter on the finger.**

Extremity Dosimetry

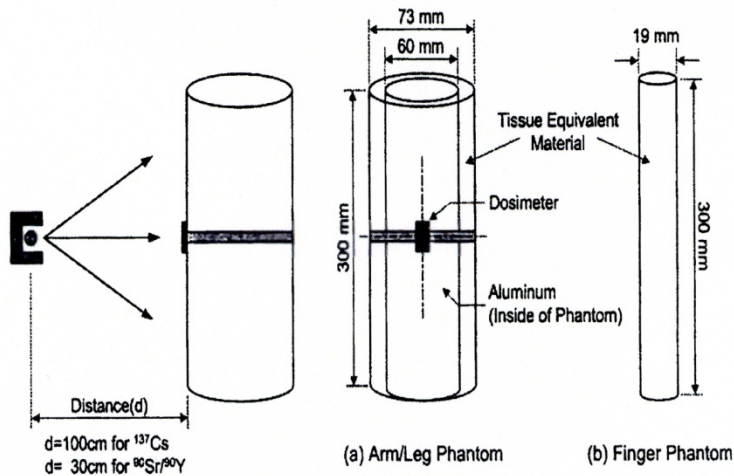

Extremity Dosimetry

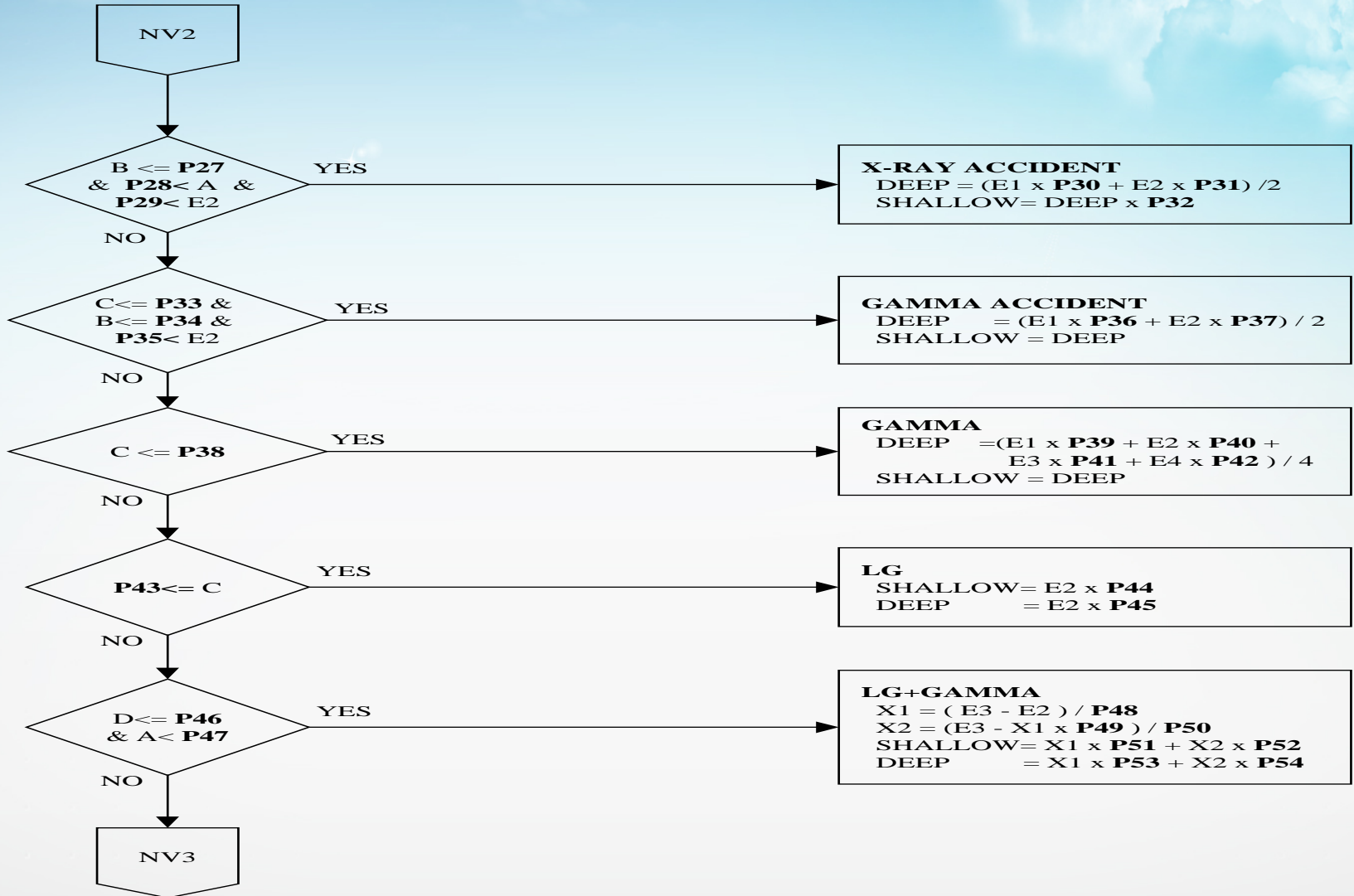

Table 1. Comparison of DCF results for Harshaw EXTRAD and Panasonic UD-807 extremity dosimeters.

Beam code	Harshaw		Panasonic	
	EXTRAD	Manufacturer ^a	UD-807	Manufacturer
High-energy photon ¹³⁷ Cs	0.94	1.0	0.89	0.94
X-ray energy				
20 keV	0.92	–	0.58	0.45
35 keV	1.13	–	0.65	0.72 ^b
53 keV	1.21	–	0.64	0.77 ^c
73 keV	1.09	–	0.68	0.84 ^d
Beta-ray energy ⁹⁰ Sr/ ⁹⁰ Y	1.14	–	1.04	1.19

Notes: ^aThe manufacturer provides DCF for only high-energy photon (cesium-137); ^{b,c,d}The manufacturer uses slightly different radiation fields for DCF calculation of dosimeters from those of ANSI 13.32-1995 (b: 30 keV, c: 50 keV, d: 70 keV).

Extremity Dosimetry



Extremity Dosimetry



Table 1. Panasonic TLD readouts of radiation workers that maintained the steam generator nozzle dam at Korean NPP.

Workers	Area 1 (mSv*)	Area 2 (mSv*)	Area 3 (mSv*)	Area 4 (mSv*)	Personal dose equivalent, $H_p(10)$ (mSv)	Personal dose equivalent, $H_p(0.07)$ (mSv)	Wearing position
A	4.71	4.20	3.85	4.30	4.25	4.25	Head
	3.01	2.82	3.08	2.97	2.96	2.96	Chest
	3.75	3.66	3.61	3.77	3.68	3.68	Back
B	2.71	2.67	2.48	2.58	2.60	2.60	Head
	2.22	1.89	2.15	2.12	2.09	2.09	Chest
	2.82	2.66	2.65	2.76	2.71	2.71	Back
C	2.63	2.29	2.35	2.41	2.41	2.41	Head
	2.01	1.86	1.93	1.88	1.90	1.90	Chest
	2.17	2.05	2.25	2.08	2.13	2.13	Back
D	2.36	2.22	2.16	2.47	2.29	2.29	Head
	1.56	1.48	1.69	1.60	1.57	1.57	Chest
	2.19	1.94	2.12	2.04	2.07	2.07	Back
E	3.67	3.55	3.38	3.74	3.57	3.57	Head
	2.76	2.50	2.88	2.81	2.73	2.73	Chest
	4.02	3.60	3.44	3.74	3.69	3.69	Back
F	2.80	2.84	2.69	2.64	2.73	2.73	Head
	1.77	1.72	1.88	1.86	1.80	1.80	Chest
	2.25	2.16	2.34	2.26	2.25	2.25	Back
G	3.70	3.65	3.28	3.47	3.51	3.51	Head
	2.79	2.47	2.64	2.63	2.62	2.62	Chest
	3.01	2.93	3.01	3.18	3.02	3.02	Back
H	2.07	2.02	1.98	1.95	2.00	2.00	Head
	1.75	1.66	1.82	1.81	1.75	1.75	Chest
	2.09	1.83	2.02	2.08	2.00	2.00	Back

'mSv*' is the modified value for each element based on mR* which is the specific TLD readout unit for the Panasonic TLD reader system.

Table 2. Harshaw TLD readouts of radiation workers who wore a TLD on the wrist while maintaining the steam generator at Korean NPP.

Workers	Element 1 (gU ^a)	Element 2 (gU ^a)	Element 3 (gU ^a)	Element 4 (gU ^a)	Personal dose equivalent, $H_p(10)$ (mSv)	Personal dose equivalent, $H_p(0.07)$ (mSv)
I	103.0	102.6	100.6	98.0	0.89	0.89
J	251.6	246.2	243.7	236.5	2.19	2.19
K	131.7	134.0	132.9	128.8	1.17	1.17
L	164.0	159.8	160.7	156.2	1.41	1.41
M	154.9	154.3	148.8	144.2	1.36	1.36
N	128.2	126.3	123.3	122.3	1.11	1.11

^a'gU' is specific TLD readout unit (generic unit) for the Harshaw TLD reader system.

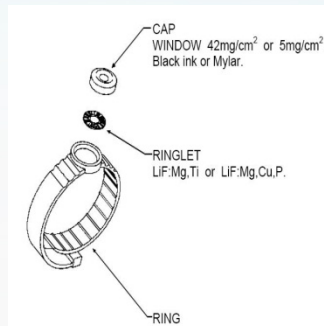

Extremity Dosimetry



Table 1. Field test results of the extremity dosimeters at Korean PWRs (maintenance on the nozzle dam in the steam generator water chamber).

Two TLDs (mSv)				Electronic dosimeter (mSv)	Wrist TLD (mSv)	Finger TLD ^c (mSv)
Worker name ^a	Position	Equivalent dose	Effective dose ^b			
A	Chest	1.65	2.12	1.68	2.19	2.92
	Back	2.42		2.55		
B	Chest	1.07	1.26	1.01	1.41	1.77
	Back	1.35		1.40		
C	Chest	0.97	1.20	0.93	1.36	2.00
	Back	1.33		1.41		
D	Chest	1.58	1.89	1.79	2.17	3.31
	Back	2.05		2.37		
E	Chest	1.80	2.13	2.04	2.46	3.18
	Back	2.28		2.70		
F	Chest	0.94	1.19	1.07	1.21	1.85
	Back	1.35		1.58		
G	Chest	2.40	2.83	2.51	2.72	4.02
	Back	3.01		3.34		

^aNames represent the different workers.

^bThe effective dose is calculated on the basis of the TLD readouts for the chest and the back. For the calculation of the effective dose from two $H_p(10)$ s on the chest and the back, the NCRP (55:50) two-dosimeter algorithm is used, in which a 55 % weighting is given to the dose on the chest (front) and a 50 % weighting is given to the dose on the back.

^cFinger TLD indicates the extremity dosimeter.

Extremity Dosimetry



Table 2. Field test results of the extremity dosimeters at Korean PHWRs (maintenance for the removal of the pressure tube feeder).

Two TLDs (mSv)				Electronic dosimeter (mSv)	Wrist TLD (mSv)	Finger TLD ^c (mSv)
Worker name ^a	Position	Equivalent dose	Effective dose ^b			
H	Chest	0.83	0.82	0.83	0.86	0.87
	Back	0.73		0.82		
I	Chest	0.60	0.63	0.75	0.87	1.03
	Back	0.60		0.67		
J	Chest	0.41	0.42	0.45	0.49	0.58
	Back	0.39		0.33		
K	Chest	0.44	0.43	0.62	0.73	0.77
	Back	0.38		0.41		
L	Chest	0.69	0.60	0.79	0.72	0.75
	Back	0.45		0.47		

^aNames represent the different workers.

^bThe effective dose is calculated on the basis of the TLD readouts for the chest and the back. For the calculation of the effective dose from two $H_p(10)$ s on the chest and the back, the NCRP (55:50) two-dosimeter algorithm is used, in which a 55 % weighting is given to the dose on the chest (front) and a 50 % weighting is given to the dose on the back.

^cFinger TLD indicates the extremity dosimeter.

Extremity Dosimetry



Table 2. Harshaw TLD readouts for radiation workers who wore a TLD on the wrist during maintenance work on the steam generators at Ulchin NPPs.

Worker	Element 1 (gU) ^a	Element 2 (gU) ^a	Element 3 (gU) ^a	Element 4 (gU) ^a	H _p (10) (mSv)	H _p (0.07) (mSv)
A	103.0	102.6	100.6	98.0	0.89	0.89
B	251.6	246.2	243.7	236.5	2.19	2.19
C	131.7	134.0	132.9	128.8	1.17	1.17
D	164.0	159.8	160.7	156.2	1.41	1.41
E	154.9	154.3	148.8	144.2	1.36	1.36
F	128.2	126.3	123.3	122.3	1.11	1.11

Notes: ^aThe Harshaw TLD reader output results as generic reader unit (gU), which is directly proportional to total light output.

Table 3. Panasonic TLD readouts for radiation workers who wore a TLD on the wrist during maintenance work on the steam generators at Wolsong NPPs.

Worker	Element 1 (mSv*) ^a	Element 2 (mSv*) ^a	Element 3 (mSv*) ^a	Element 4 (mSv*) ^a	H _p (10) (mSv)	H _p (0.07) (mSv)
A	0.96	0.92	0.82	0.84	0.86	0.86
B	0.95	0.87	0.86	0.89	0.87	0.87
C	0.55	0.56	0.47	0.46	0.49	0.49
D	0.51	0.48	0.44	0.44	0.45	0.45
E	0.83	0.73	0.73	0.72	0.73	0.73
F	0.74	0.88	0.65	0.70	0.72	0.72

Notes: ^amSv* is the modified value for each element based on mR* which is the specific TLD readout unit for the Panasonic TLD reader system.

Extremity Dosimetry



- Characteristics of radiation fields for high-dose tasks and **field test** for contact operations were carried out using TLDs for the whole-body and wrist (**chest, back, wrist, finger**).
- The TLD readouts from each element were almost similar: **Hp(10) was equivalent to Hp(0.07)**.
- Incident radiation with high exposure rates consists of **high-energy photons (high penetration)**.
- Single element extremity dosimeter (finger dosimeter) is sufficient for monitoring Hp(0.07).
- **Wearing conditions** were determined: **$\geq 25\text{mSv}$ in a single access to the RCA or 50mSv in a single task.**
- Extremity dose at the finger was $\sim 50\%$ higher than the E and equivalent dose at wrist was $\sim 20\%$ higher than the E.

**Thank you very much.
Any Question?**

